



# ZERAMEX<sup>®</sup> P6

User guide



+ swiss made

**NOTE:**

ZERAMEX®P6 is prosthetically  
NOT compatible with earlier  
ZERAMEX®P generations.

In the event of any uncertainty,  
please contact us at:  
00800 93 55 66 37

## ZERAMEX®P6

- 4 ZERAMEX®P6 system overview
- 7 Case planning in five steps
- 10 Indications/contraindications
- 12 Tools
- 14 Sterilization and instrument care
- 16 Surgery phase
- 22 Provisional restoration
- 24 Taking impressions
- 26 Prosthetic restoration
- 29 Screw-retained connection
- 34 CAD/CAM workflow
- 37 Bonded connection
- 41 Product range
- 50 General information

**Dear ZERAMEX® user,**

Ceramics are being used more and more often in dental applications. In prosthetics and standard for abutments for a long time, ZERAMEX® makes possible completely metal-free restoration using implants with excellent properties.

ZERAMEX® P6, for example, is the first two-piece and reversible screw-in ceramic implant that uses carbon ceramic technology to achieve a performance comparable to none other. You, too, can offer your patients the advantages of metal-free rehabilitation.

# ZERAMEX® P6 System overview

The system for all common indications, including single-tooth restorations and partially edentulous or edentulous jaws

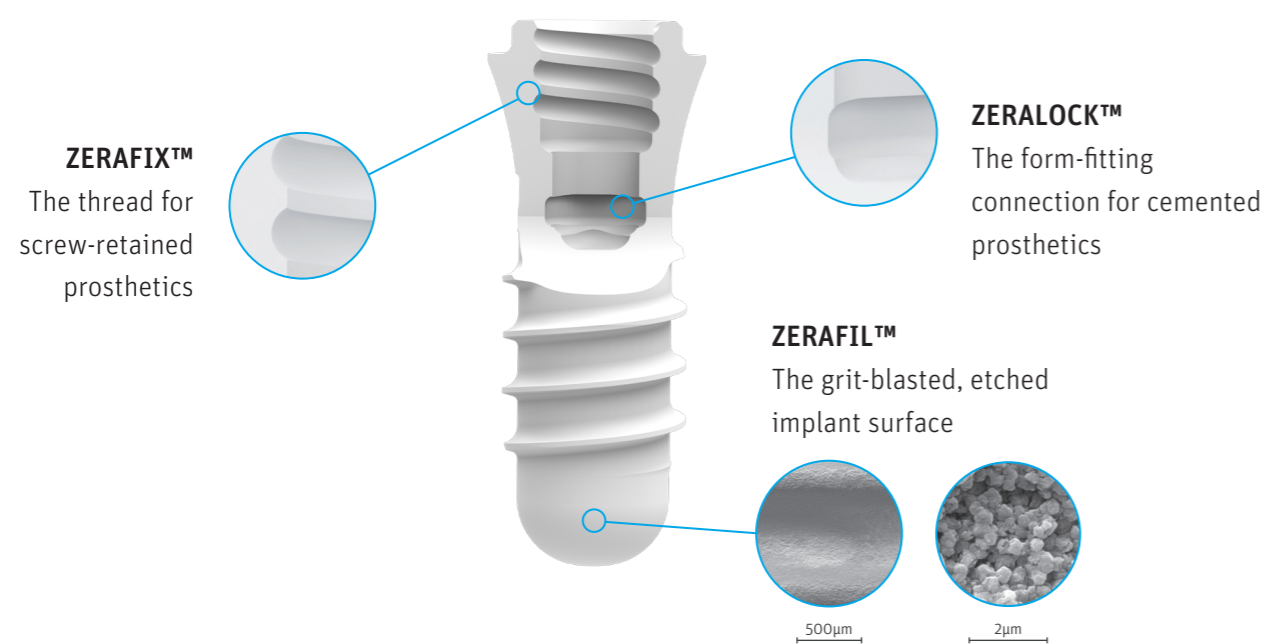

## Color coding and sizes

	Small Neck* Ø 3.3mm	Regular Neck Ø 4.1mm	Regular Neck Ø 4.8mm
Ø Platform	4.0mm	4.8mm	4.8mm
Ø Endosseous	3.3mm	4.1mm	4.8mm
Collar height	1.8mm	1.8mm	1.8mm
8mm	●	●	●
10mm	●	●	●
12mm	●	●	●

\* Limited indications

## Surgery – Temporary Restorations – Taking Impressions – Prosthetics

	ZERAMEX® P6 Ø3,3mm SN	ZERAMEX® P6 Ø4,1mm RN	ZERAMEX® P6 Ø4,8mm RN
<b>Implants</b> Material: ZrO <sub>2</sub> -ATZ	 P15508 P15510 P15512	 P16508 P16510 P16512	 P17508 P17510 P17512
<b>Prosthetic platform</b>	<b>SN (4.0mm)</b>	<b>RN (4.8mm)</b>	
<b>Healing caps</b> Material: PEEK	 P35500	 P36500 P36502	
<b>Soft tissue management</b> Material: PEEK, PEEK-CW30	 P35503 P35504 P35530	 P36503 P36504 P36530	
<b>Impression-taking</b> Material: Al, PEEK-CW30	 P35510 P35512 P35513	 P36510 P36512 P36513	
Material: PEEK, PEEK-CW30	 P35514	 P36514	
<b>Abutments, screwed</b> incl. screw; Material: ZrO <sub>2</sub> -ATZ, VICARBO®	 P15501 P15502 P15515	 P16501 P16502 P16515	
	 P15530 P15531	 P16530 P16531	
<b>ZERALOCK™ abutments</b> (cemented) Material: ZrO <sub>2</sub> -ATZ	 P15305 T15315	 P16305 T16315	
<b>LOCATOR®, cemented</b> Material: ZrO <sub>2</sub> -ATZ	 P15202 P15203 P15205	 P16202 P16203 P16205	
<b>Lab tools</b> Material: Al, PEEK	 P35520 P35453 P35450 P35451	 P36520 P36453 P36450 P36451	
<b>Abutment screws, individual</b> Material: VICARBO®, PEEK-CW30	 P15450 P15451 P35550 Further information: see separate data sheet	 P16450 P16451 P36550 Further information: see separate data sheet	

# The connection

Hexagonal platform for durable, secure retention:

The ZERAMEX®P6 platform offers certainty in impression taking and in temporary and permanent prosthetic restorations.

The hexagonal indexing of the implant platform facilitates tension-free indirect impressions and creates the perfect fit and anti-rotation protection of ZERAMEX® P6 abutments in six possible positions. The ZERAMEX® P6 abutment made of high-strength zirconium dioxide (ZrO2-ATZ-HIP) has a precise fit against the implant shoulder.

In combination with the VICARBO® screw (carbon-fiber reinforced) the abutment makes a high-strength, albeit tension-free, screw-retained ceramic-ceramic connection.

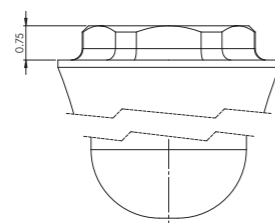
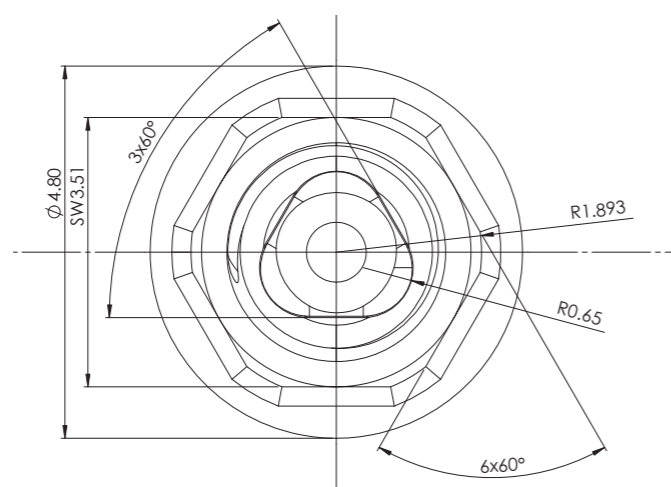

## VICARBO® screw made of carbon-fiber-reinforced plastic:

Carbon-fiber-reinforced plastic is the ideal material for the screw-retained ZERAMEX®P6 implant with clear advantages:

- Metal-free & biocompatible in compliance with ISO10993 for long-term implants
- Modulus of elasticity: >160 GPa.
- Flexural strength: > 1,100 MPa
- Tensile strength: 2,000 MPa (Titanium grade 5: 1,100 MPa)

Based on the outstanding properties of this high-performance material and the screw design, an extremely strong and seamless connection to the implant is made.

The internal carbon fibers extend throughout the length of the screw and absorb tensile forces consistently.



# Treatment planning in five steps

## 1 Preparation phase

As with any surgical procedure, implantation also requires proper professional preparation. Preparation includes a thorough dental and general health examination which includes taking X-ray images and a detailed discussion with the patient regarding their prior medical history. Also, treat any gum disorders in advance. The options and intentions for later prosthetic restoration (item 5) should be included in the discussion from the start. Use this baseline to work out the individual therapy plan and create a protocol. CT and DVT can be used to gather information about bone conditions which are difficult to diagnose. The bone and its quality decide ultimately on the position and number of implants.

## 2 Implant selection

Implant lengths and diameters are based on X-ray images. In general, always choose the largest possible diameter. The buccal/vestibular wall thickness must be at least 1mm to ensure proper perfusion. If this is not possible, bone grafting is necessary.

## 3 Bone preparation

Follow the drilling protocol on pages 16 to 19. You must provide constant cooling during implantation because temperatures higher than 42 degrees Celsius threaten to alter bone structure and affect osseointegration!\*

**Important:** Insert the drill only to the specified marking. All implants can be used in two insertion depths. Follow the corresponding drilling protocols.

### Limited applications

The ZERAMEX® P6 implant small, ø 3.3mm, SN, may be used only under certain conditions: front tooth area in the lower jaw, lateral incisors in the upper jaw. Exception: LOCATOR®\*\*

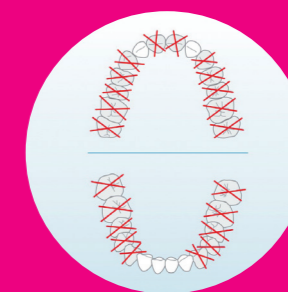

\*\* Always use the implant with the largest possible diameter.

\* ZERAMEX®P6 implants are part of an overall system and may be used only with the components designed for the system. Dentalpoint AG shall not be held liable for any damage arising from improper use or from using non-original components.



## 4 Implant insertion

We recommend tightening the implant by hand and not tightening at more than 15rpm. The implant is **not** set at bone level. The implant shoulder must be easily accessible in order to tighten or cement the abutment correctly after the initial healing phase. Very good primary stability is important. Use a healing cap to cover the implant after the placement (max. 5Ncm) and close the gums. A gingiva former can be used directly in exceptional cases. The minimum required healing period is three months for the lower jaw and six months for the upper jaw.

### DO NOT OVER-TIGHTEN!

The maximum torque is 35Ncm for SN implants and 45Ncm for RN implants. Do not exceed this torque.

The required torque is ALWAYS less than the maximum torque for the particular bone quality (less torque for soft bone) and implant length (less torque for short implants).

Recommendation: 20–30Ncm

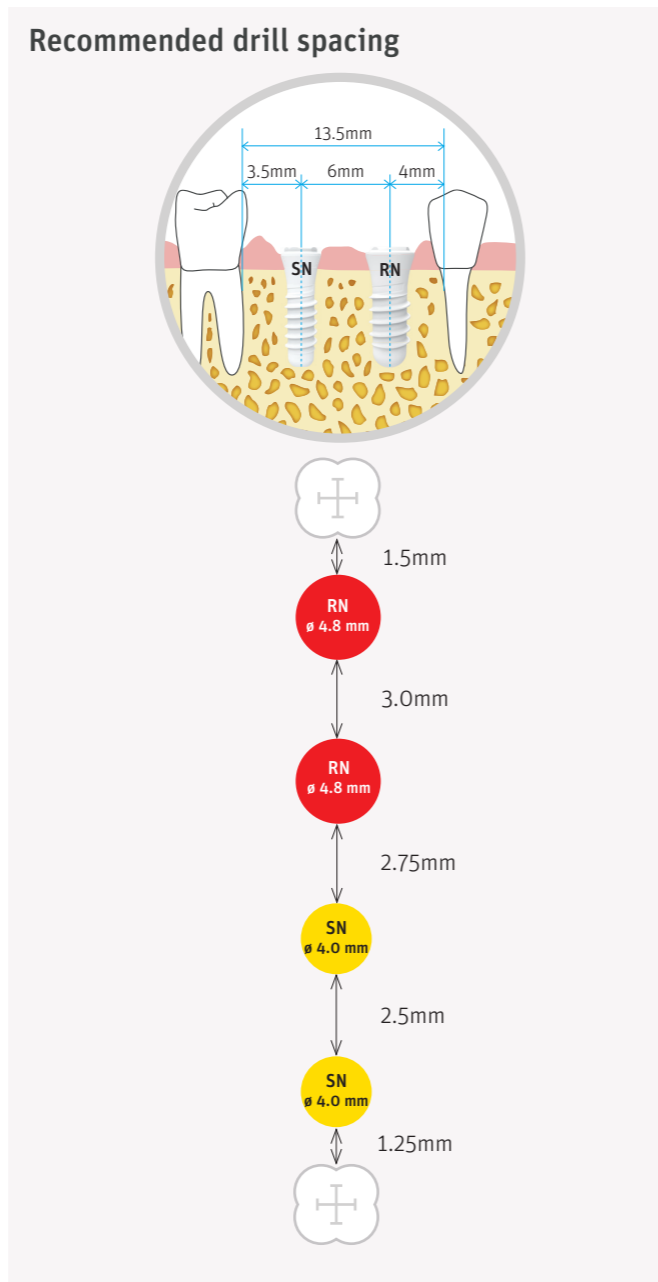

## 5 Position of the implant shoulder

SN  
ø 4.0mm

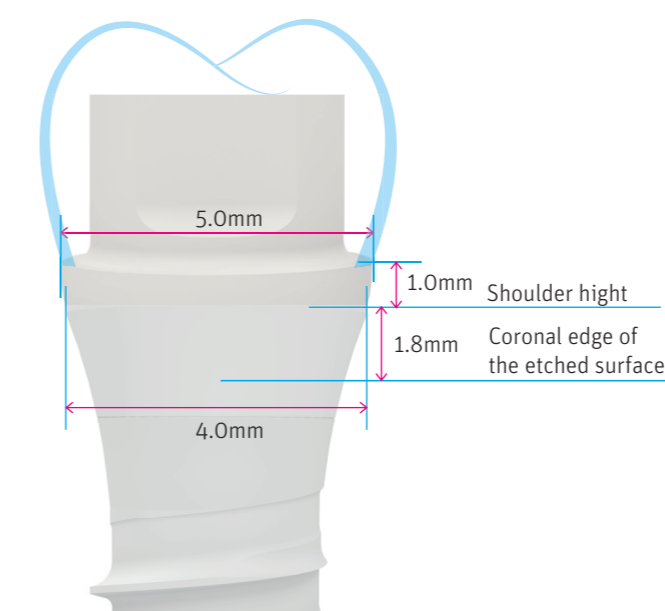

RN  
ø 4.8mm

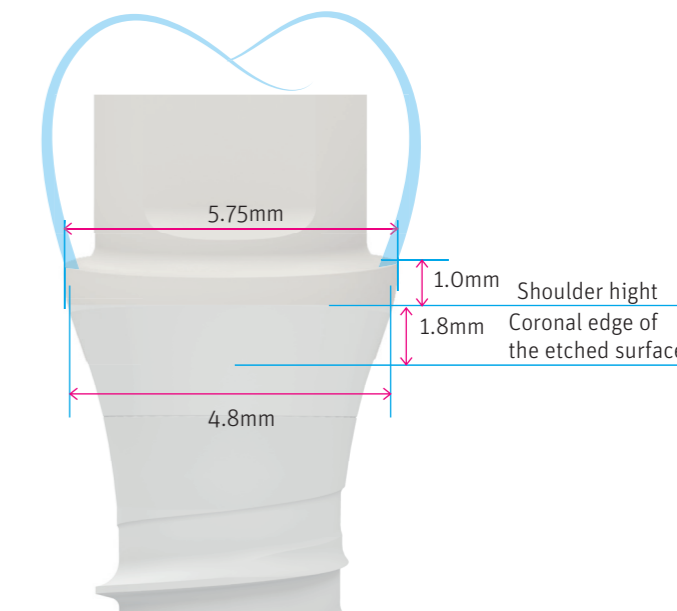

During planning, take note of the different abutment types and the respective shoulder heights (see overview p. 36).

The additional shoulder heights for screw-retained abutments widen the crown edge. This should be taken into account during implant planning.

Note: The implant shoulder must be placed at least 0.8mm supracrestal. If a tooth is missing, it should be 1 to 1.5mm under the gingival margin.

## 6 Prosthetic restoration

Basically two methods are available to you for prosthetic restoration: screw-retained restoration with straight and angular ZERAMEX® P6 abutments or cemented restoration with straight and angular ZERALOCK™ abutments or Locator®.

You can find more information starting on page 26:  
Planning for prosthetics

# Indications/contraindications

## Intended use

The ZERAMEX® Dental Implant System is intended to be surgically placed in the bone of the upper and lower jaw to provide support for prosthetic devices, such as artificial teeth, in order to restore chewing function. It can be used for single or multiple unit restorations.

## Indications

The ZERAMEX® Dental Implants are indicated for delayed loading. ZERAMEX® dental implants are specially indicated for patients with metal allergies and chronic illnesses due to metal allergies. The ZERAMEX® dental implants with enossal Ø 3.3mm or 3.5mm may only be used in the anterior teeth in the lower jaw and lateral incisor in the upper jaw. Exception: restorations on LOCATOR® abutments.

<p><b>Contraindications</b></p> <p>Implantation is contraindicated in the following conditions:</p> <ul style="list-style-type: none"> <li>• Poor bone quality, i.e. if a stable fit of the implant (primary stability) cannot be assured</li> <li>• Non completed bone growth</li> <li>• Acute or chronic infectious diseases</li> <li>• Sub-acute chronic jaw osteitis</li> <li>• Diseases resulting in microvascular impairments</li> <li>• Systemic diseases</li> <li>• General bad medical condition of the patient</li> <li>• Any kind of abuse (alcohol, nicotine or drug abuse)</li> <li>• Poor oral hygiene as well as poorly motivated, non-co-operative patients</li> <li>• Vulnerable patient groups (e.g. lactating women)</li> </ul>	<p><b>Please note</b></p> <p>The following specifications are an outline of the most important operational steps. They are not supposed to be a complete instruction and are not suitable for immediate application of the ZERAMEX® system. We highly recommend a briefing by an experienced user.</p> <p>Documentation / Traceability: The manufacturer recommends complete clinical, radiological, photographic and statistic documentation. Traceability of the implants has to be assured. Use the adhesive labels enclosed in the sphere package for documentation in the patient file.</p>
--	--

## Note

Please consider the general contraindications valid in the field of implantology. Parodontal problems require restoration prior to implantation.

## Side effects, interactions and precautions; complications with ZERAMEX® implants

Immediately after the insertion of dental implants, activities that demand considerable physical exertion should be avoided. Information related to side effects, interactions and precautions, complications with ZERAMEX® implants should be provided to the patient. Possible complications following the insertion of dental implants are: Temporary symptoms: Pain, swelling, phonetic difficulties, gingival inflammation.

More persistent symptoms: Chronic pain in connection with the dental implant, permanent paresthesia, dysesthesia, loss of marginal bone, osteolysis, poor or no osseointegration, localized or systemic infection, oroantral or oronasal fistulae, unfavorably affected adjacent teeth, irreversible damage to adjacent teeth, fractures of implant, jaw, bone or prosthesis, esthetic problems, nerve damage, exfoliation, hyperplasia.

## Warning

Products must be secured against aspiration when handled intraorally. Aspiration of products may lead to infection or unplanned physical injury. Despite the high success rates with ZERAMEX® implants, failures cannot be excluded. Reasons are case-specific and often not obvious. They should be documented and reported to the manufacturer.

## Caution/Precautions

### a. Clinical use

Sterile handling is essential. ZERAMEX® implants and healing caps are for single use only. A previously used, non-sterile or contaminated implant or healing cap must not be used under any circumstances. Re-use of single use devices may lead to infections, inflammations or loss of the implant.

### b. Handling of storage and sterile package

The storage package is only to be opened shortly before implantation. The sterile package has to be checked for damages prior to opening. Any damage of the sterile package (blister) might affect sterility of the contained products. When taking the implant out of the package, please follow the valid instructions regarding aseptic conditions. ZERAMEX® implants have to be stored in their original package and in a cool (ambient temperature) and dry environment and have to be protected against direct sunlight.

# ZERAMEX®P – Tools

## ZERAMEX®P Rosedrill

ø2,2mm  
P35601



## ZERAMEX®P Pilot Drill

ø2,2mm  
P35602



## ZERAMEX®P Depth Gauge

ø2,2mm  
P35651



ø3,5mm  
P36651



## ZERAMEX®P Ratchet

Ratchet adapter unit  
P48932



Surgical ratchet  
P48935

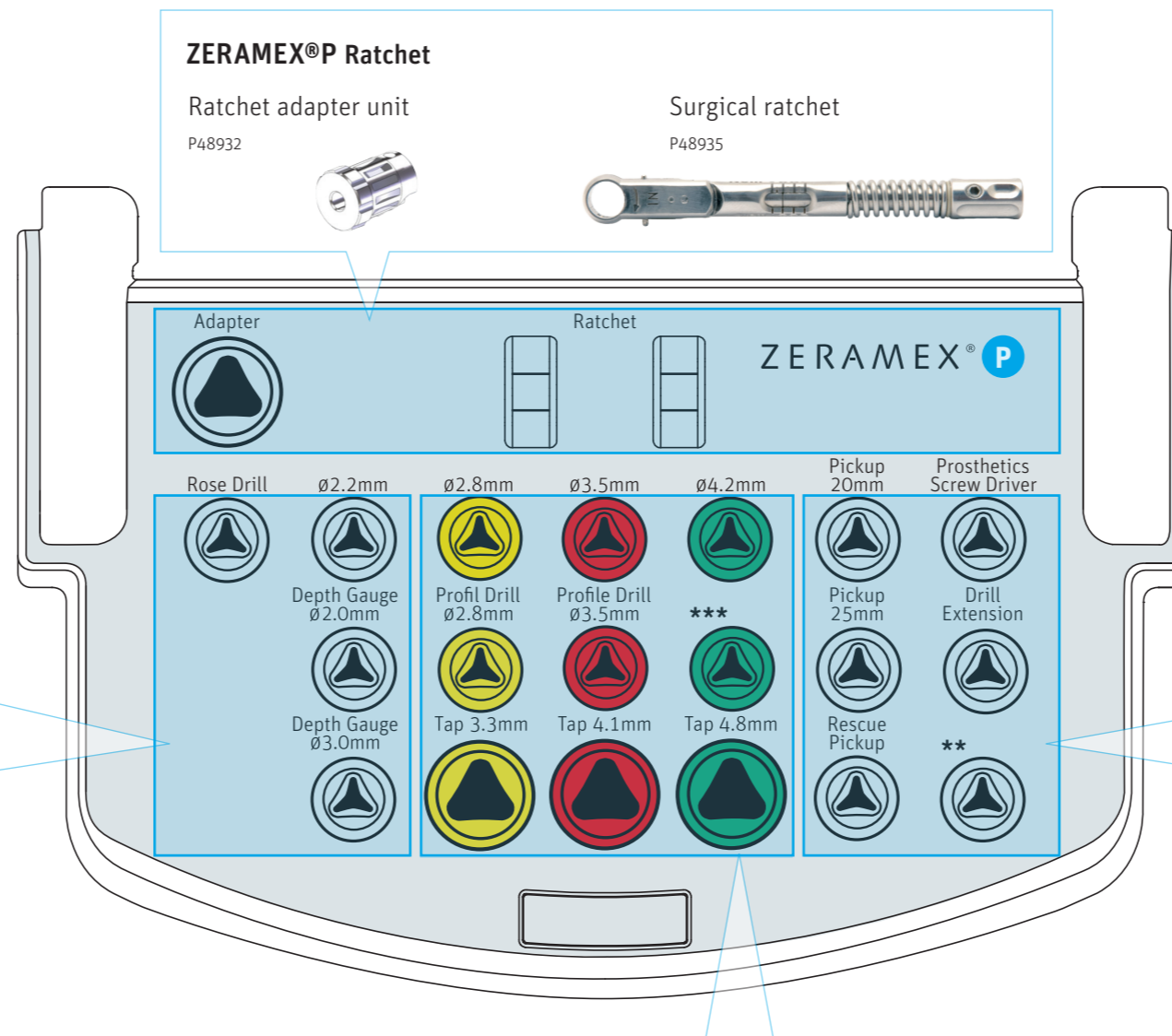

Max. use of drill: 10 to 20 times  
(depending on bone quality)  
Max. use of pickup: 10 to 20 times

## ZERAMEX®P Pickups

20mm  
T38620

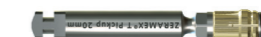

25mm  
T38625



Rescue-Pickup  
T38622



## ZERAMEX®P Prosthetic wrench

P38623



## Drill extension

C7650



\*\* ZERAMEX® Alignment

Tool

T38626



## ZERAMEX®P Drill

ø2,8mm  
P35633



ø3,5mm  
P36633



ø4,2mm  
P37633



## ZERAMEX®P Profile Drill

ø2,8mm  
P35622



ø3,5mm  
P36622



\* Reserve: This slot remains free for system expansions

## ZERAMEX®P Screw Tap

ø3,3mm  
P35620



ø4,1mm  
P36620



ø4,8mm  
P37620



### IMPORTANT:

ZERAMEX® P6 is based on a design that is one of the scientifically most documented implant systems. It is placed using the comparable surgical protocol like the Straumann® Standard Plus Implant. ZERAMEX® has its own instrument kit. A special pickup for inserting and a prosthetic wrench are needed.

\*\*\* The 4.8-mm implant is almost cylindrical, which is why a profile drill does not have to be used. This is why there is no profile drill in the tray.

### GUIDED SURGERY

You can use the Straumann® Guided Surgery System to prepare the implant bed. Guided implant positioning is not supported.

# Guidelines for sterilisation and instrument care in accordance with EN ISO 17664

## Reprocessing and preparing medical devices/ General requirements

Refer to the legal regulations and guidelines which are valid for medical office practices and hospitals in your country. This applies in particular to specifications for the effective denaturation of prions. Treatment always involves a risk of contamination and infection. Take preventive measures to actively eliminate the risk or to reduce it as much as possible. These measures include:

- Evaluation of the risks that accompany the medical intervention; decision on appropriate protective measures
- Development of systematic procedures for the work flow, in order to prevent contamination and injuries
- Careful recording of each patient's medical history to be aware of the individual contagion risk.

All medical devices that have been opened and laid out for use are to be considered contaminated and are to be reprocessed in the same way as used equipment. Organize the transport of contaminated devices in such a way that no staff members, co-workers or third parties are endangered. All personnel must wear the appropriate protective clothing and gloves.

Medical products may corrode if they are stored in a physiological saline solution. Instruments are to be submerged fully in the sterilisation trays, without air bubbles. The use of demineralised water to rinse instruments after disinfection is absolutely necessary to prevent water spots and the formation of crystals. These disrupt the subsequent sterilisation process.

You are responsible for the sterility of the products you use. For this reason, you must use validated procedures for the cleaning, disinfection, and sterilisation of your medical devices and products. You must ensure regular maintenance of your equipment, and you must observe all process parameters in every cycle. Please note the shelf life of products in sterile packaging (manufacturer's data sheet). Reprocessing ends with the release for use. Sterilisation

indicator and sterilisation date must be recorded on every sterile packing.

### Important:

- Products that are delivered in non-sterile condition (e.g. drills and abutments) must be sterilised before they are used on a patient for the first time.
- After use, all reusable medical devices must be reprocessed in accordance with the described procedure.

### Automated reprocessing

For automated cleaning to be effective, it must be preceded by manual cleaning. This removes large impurities (blood, tissue and bone fragments). Rinse instruments under cold, running water immediately after use, and use a fine nylon brush to clean off the large impurities. Then place the instruments in the cleaning tray of your disinfection and cleaning device.

### Ultrasonic cleaning (optional)

If the instruments are very soiled and it is not possible to remove large impurities manually, cleaning in an ultrasonic bath is recommended. Important: The cleaning agent must be compatible with the products. Please observe the application times and concentrations specified by the manufacturer.

### Automated cleaning

Only use properly suited cleaning and disinfection equipment for your automated cleaning tasks. These should be validated by the user on the basis of established cleaning processes. Place parts in the cleaning tray in accordance with instructions provided by the manufacturer of the equipment. There are commercially available cleaning and disinfection agents. We recommend: „neodisher MediClean“ and „neodisher Z“ as the neutralising agent (both from Dr. Weigert, Hamburg). Follow the manufacturer's information on dosage and use. We recommend fully demineralised water to clean instruments and for the final rinsing procedure. The selected cleaning and disinfection program should run with the optimal temperature for removal of blood (45–55°C).

### Example of a cleaning program:

- |  |        |
|--|--------|
| • Pre-rinse with cold water                    | 4 min  |
| • Clean with alkaline cleaning agent at 45–55° | 10 min |
| • Neutralise                                   | 6 min  |
| • Intermediate rinse                           | 3 min  |
| • Disinfection                                 | 5 min  |
| • Drying (max. 130°C)                          | 5 min  |

Before the sterilisation process, check the cleaned, dried and disinfected parts for corrosion and damage.

### Manual reprocessing

Place the products in a disinfectant solution after use to prevent them from drying out and as a personal protection measure. Remove large impurities (blood, tissue and bone fragments). To do this, take the instruments from the tray and clean them under cold, running water with a fine nylon brush. Never use a metal brush or steel wool for this step!

### Ultrasonic cleaning (optional)

If the instruments are very soiled and it is not possible to remove large impurities manually, cleaning in an ultrasonic bath is recommended. Important: The cleaning agent must be compatible with the products. Please observe the application times and concentrations specified by the manufacturer.

### Cleaning

Before cleaning the products, rinse them under a flow of cold, demineralised water. Disassemble all products that can be taken apart. A suitable cleaning agent is, for example „neodisher MediClean“ (Dr. Weigert, Hamburg). Place the products in a fresh cleaning bath, in accordance with the manufacturer's information. Clean the parts with a nylon brush. Rinse the products several times with demineralised water and check for corrosion or damage.

### Disinfection

Place the products that need to be disinfected in a fresh disinfectant bath. The liquid must cover them completely. ID 212 instrument disinfection (Dürr System Hygiene) is a suitable disinfectant, for example.

### Rinsing and drying

After disinfection of the products, rinse thoroughly with demineralised water. \*Use residue-free compressed air to dry the instruments.

### Sterilisation

Re-assemble the dismantled medical devices before you start the sterilisation procedure. Sort the separately cleaned and disinfected products into the appropriate sterilisation tray. You may also sterilise products individually. Then pack the filled trays and/or the individual products in a non-reusable bag suitable for use in a steam steriliser (single or double bags) and/or in a sterilisation container. Bags for use in steam sterilisation processes must meet the specifications of DIN EN ISO 11607 / ANSI/AAMI ST79 / AAMI TIR12:2010. Two examples are: a non-reusable sterilisation bag (single or double bag) with temperature tolerance of at least 137°C (ca. 278.6°F) and vapour permeability that allows adequate protection from mechanical damage, or else a sterilisation container, which must undergo regular maintenance according to the specifications of the manufacturer. Instruments such as drills, thread cutters and depth gauges have dedicated positions in the ZERAMEX® XT Surgery tray, REF XT48850, where they can be placed for sterilisation. Sterilisation is achieved in the autoclave at USA: 132°C for the duration of at least 4 minutes holding time and subsequent 20 minutes drying. Rest of World: 134°C for the duration of at least 7 minutes holding time and subsequent 20 minutes vacuum drying. The parts should then be marked with a sterilisation date and placed in dry and dust-free storage. USA: If the parts are stored after sterilization, they must be stored in FDA cleared accessories such as wraps and containers.

**CAUTION!**  
The drilling depth is up to 0.4mm deeper than the corresponding implant

# Depth marks

Standard insertion depth **1.8mm** transgingival

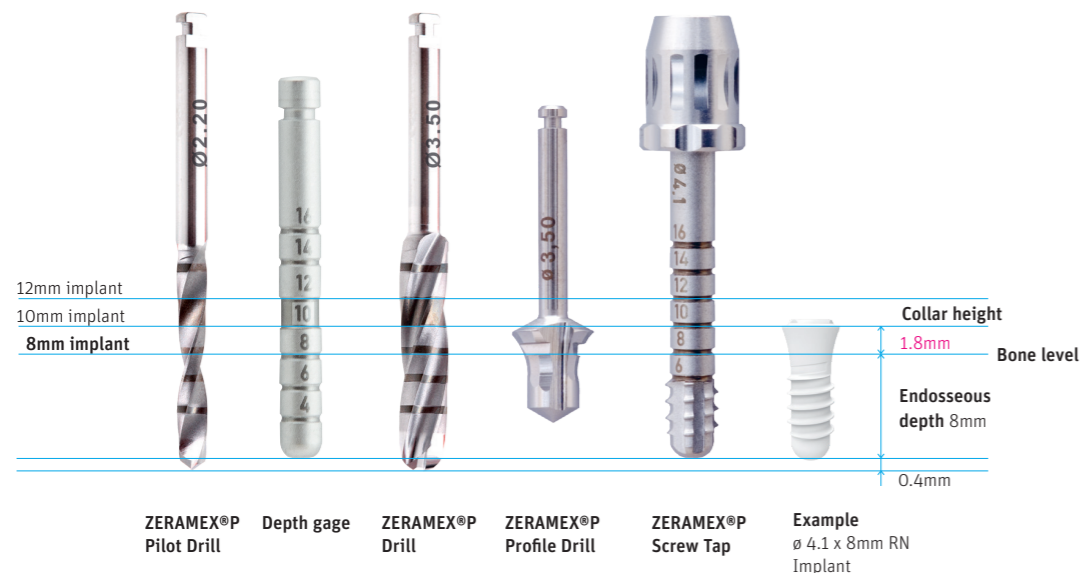

Optional insertion depth to no less than **0.8mm** transgingival

IMPORTANT: \*The endosseous depth of the implants will be up to 1mm higher.

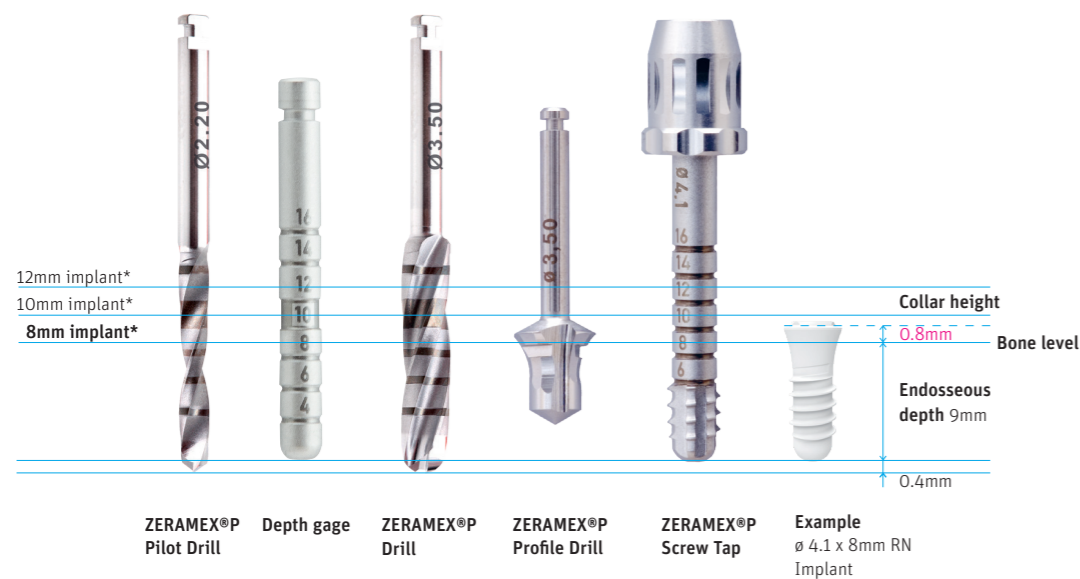

## STERILIZATION BEFORE SURGERY

Surgery prep involves steam sterilizing the surgery tray (surgical instruments) at 134° / duration: 18 minutes

## IMPORTANT:

During surgery, keep a container with saline solution at hand. If the drills and instruments are used more than once, place them in the saline solution in the interim.

# Drilling protocol ø 3.3mm SN

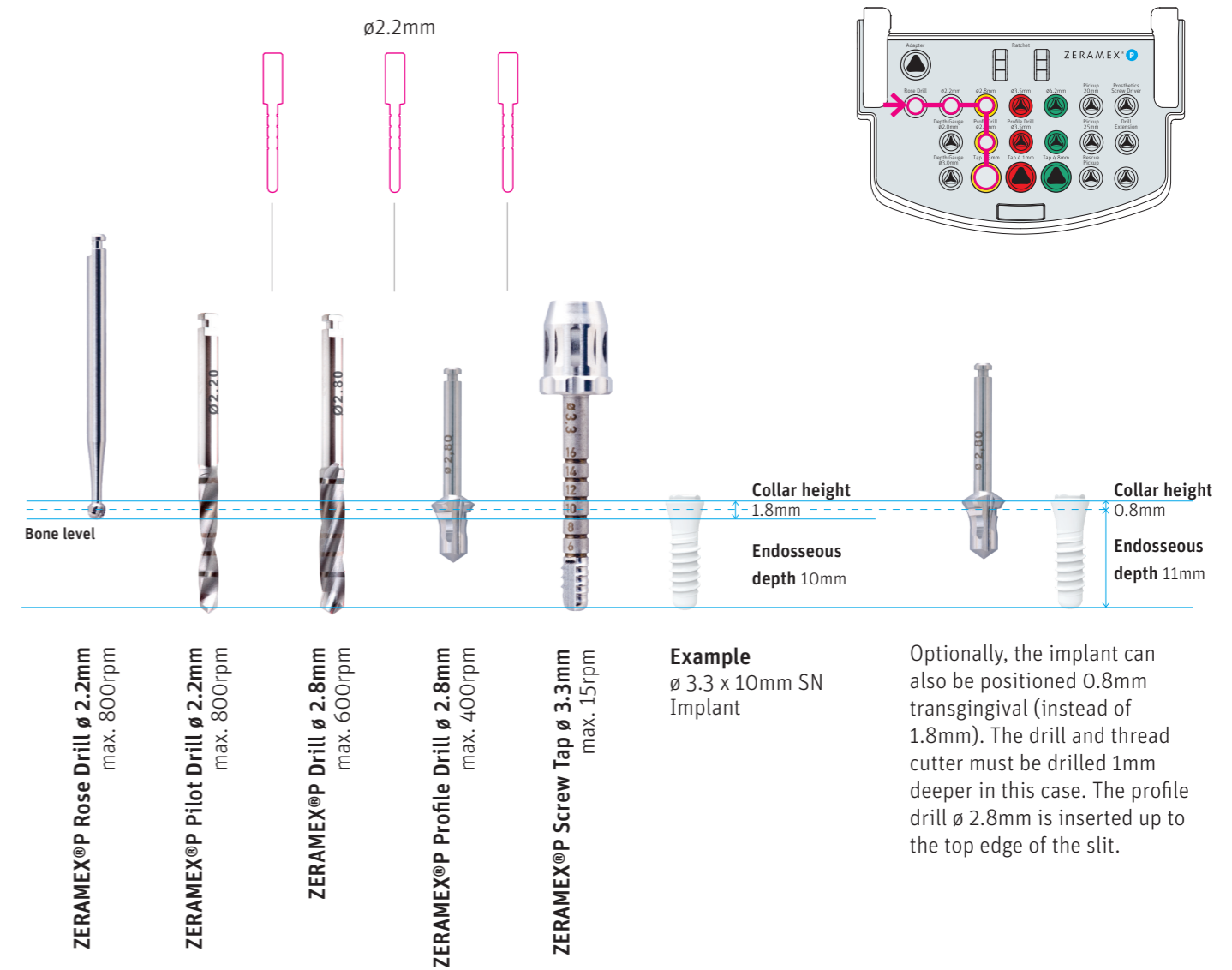

Endosseous  
ø 3.3mm



## NOTE:

- With 3.3mm-diameter implants, do not exceed a torque of 35Ncm.
- Implants with a diameter of 3.3mm have limited indications; see page 8.

## RECOMMENDATION:

Full-length for bone class 1; only precut on the coronal side for bone class 2.



## Drilling protocol ø 4.1mm RN

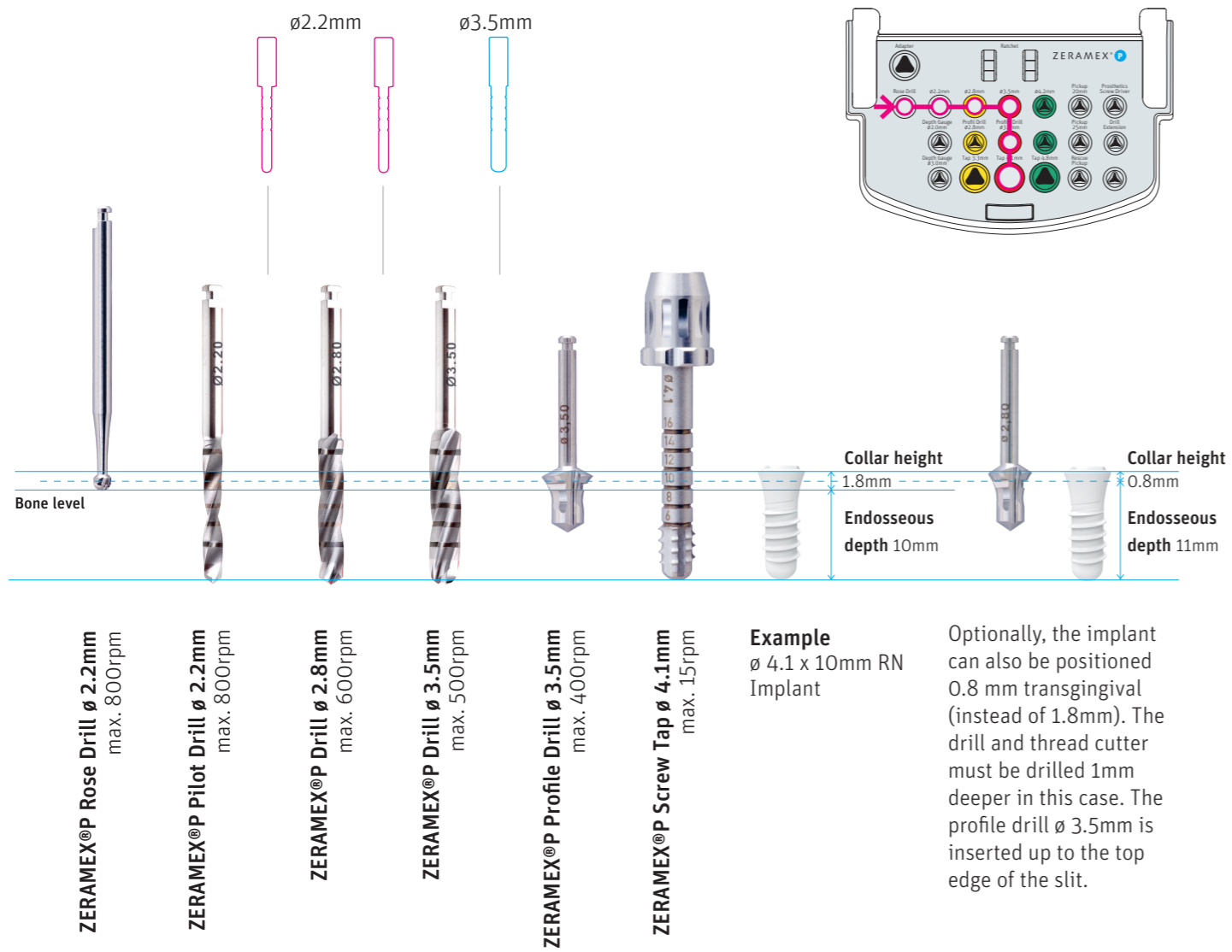

## Drilling protocol ø 4.8mm RN

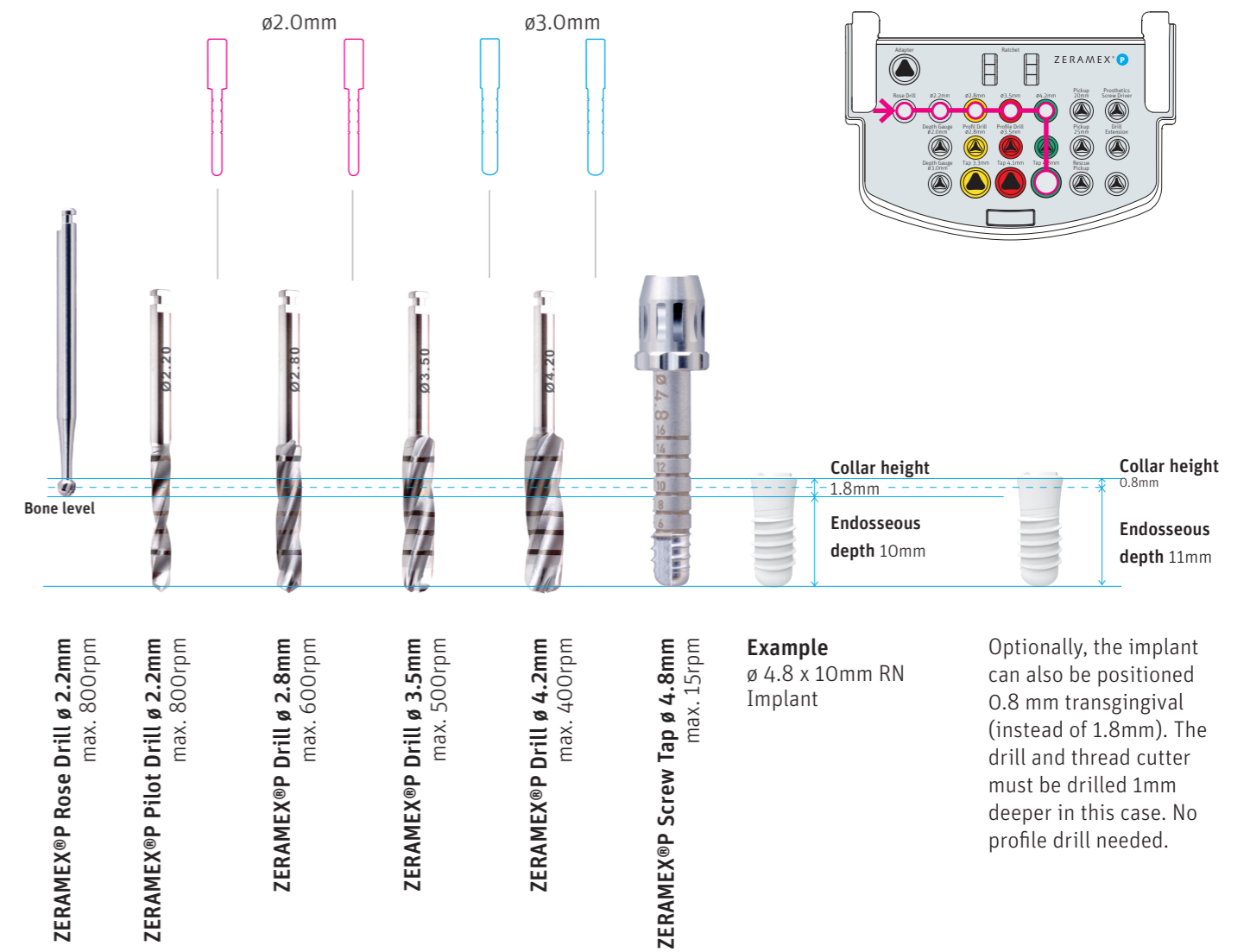

Endosseous  
ø 4.1mm



**NOTE:**

With 4.1mm-diameter implants, do not exceed a torque of 45Ncm.

**RECOMMENDATION:**

Full-length for bone class 1; only precut on the coronal side for bone class 2.

Endosseous  
ø 4.8mm



**NOTE:**

With 4.8mm-diameter implants, do not exceed a torque of 45Ncm.

**RECOMMENDATION:**

Always precut the entire thread length.

## Handling

**Required material:**

- Implant ID (Z99905)
- Pickup (T38620/T38625)
- Ratchet Adapter Unit (P48932)



1. Box contents: Implant in a spherical packaging, matching healing cap, package leaflet. **Note:** Check the required implant dimensions before opening the package.

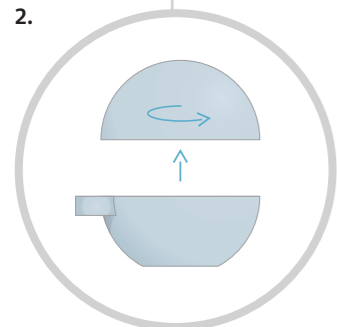

2. Open the sphere by twisting.

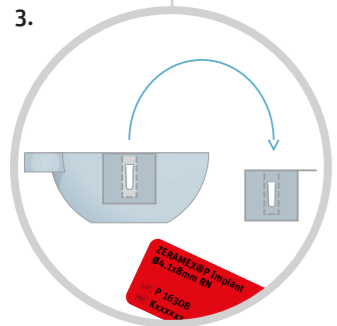

3. Remove the sterile secondary blisters and patient labels from the sphere.

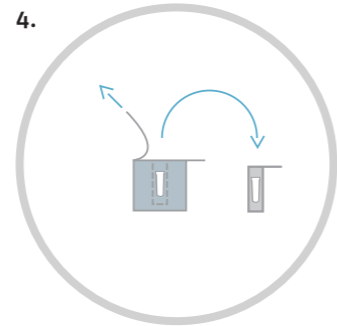

4. Open secondary blisters and remove the sterile primary blisters from the secondary blisters.

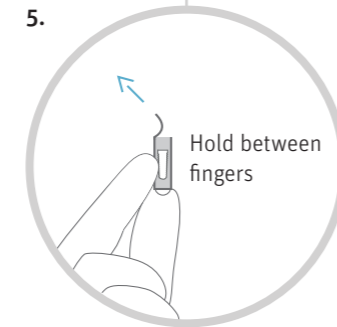

5. Break the seal shortly before use.

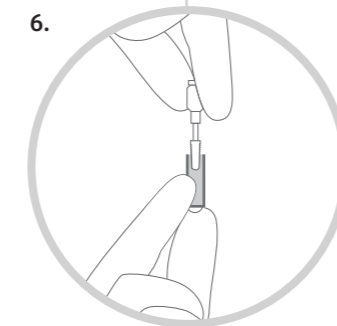

6. Pick up the implant using the pickup tool (inserted in the ratchet adapter; snap in the triangular socket).

## Insert and seal the implant

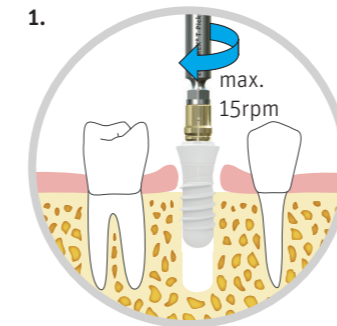

1. Slowly screw the implant into the precut drill hole.  
**Important:** Never use the rescue pickup for insertion.

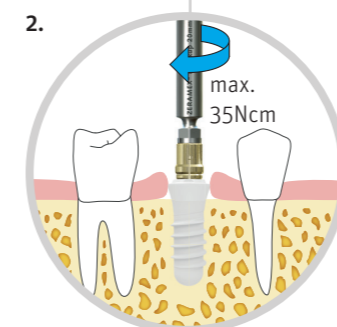

2. Tighten the implant using the ratchet. Recommendation: 20–30Ncm.

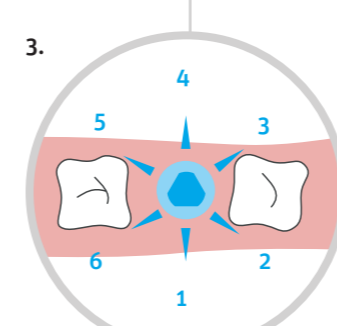

3. Optional for "extreme angles": For angular abutments, the alignment of the triangular socket can be adjusted using the adjustment tool (T38626).  
▶ = possible abutment positions

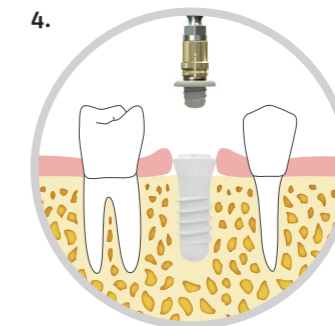

4. Close the implant with the healing cap. Use the pickup or alignment tool (T38620/T38625), and carefully tighten the healing cap (max. 5Ncm).

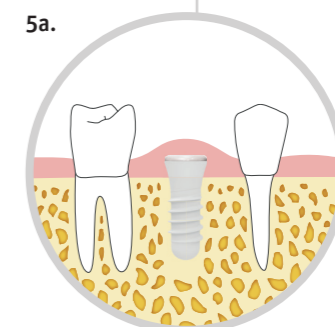

5a. **Version 1:** Closed healing (recommended).

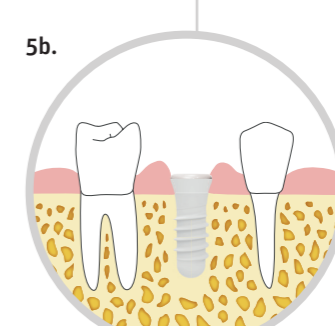

5b. **Version 2:** Open healing; note closely adjacent gingiva.

**DO NOT OVER-TIGHTEN!**  
The maximum torque is 35Ncm for SN implants, 45Ncm for RN implants. Do not exceed this torque. The pickup has a predetermined breaking point of approximately 50Ncm. Maximum speed: 15rpm



## Temporary restoration

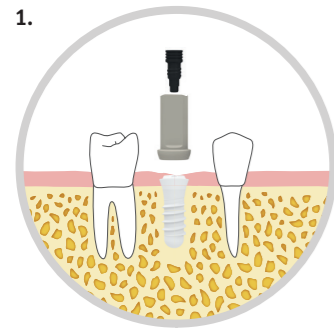

1.

1. Place the temporary abutments, and tighten using the prosthetic wrench (max. 15Ncm).

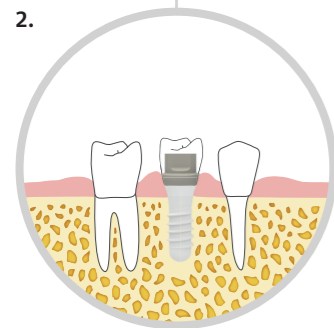

2.

2. If necessary, work on the provisional extra-orally and provide it with a provisional crown.

### Required material:

- ZERAMEX®P Provisional SN/RN (P35530/P36530)
- ZERAMEX®P Prosthetic Wrench (P38619/P38623)

### Processing the provisional:

It is preferable to machine the plastic with fine-grain diamond-coated instruments at a high speed. This is done extra-orally with slight pressure and effective cooling.

### General:

Bear in mind that metal-free plastic prosthetic components have a different feel than metal to the user. Familiarize yourself with this beforehand.

### DO NOT FORGET!

The maximum wearing time of the temporary abutments is 180 days.

### NOTE:

All abutments and abutment fixation screws provided non-sterile MUST be sterilized prior to use with the sterilization parameters provided in our "Guidelines for sterilization and instrument care" (Art. PP99926).

## Soft tissue management with gingiva former

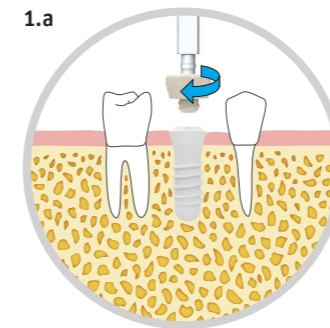

1.a

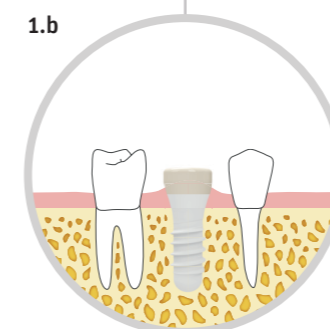

1.b

**1a/b. Placement:** Place the gingiva former on the prosthetic wrench and carefully screw in clockwise to the full depth under slight pressure. (max. 5Ncm)

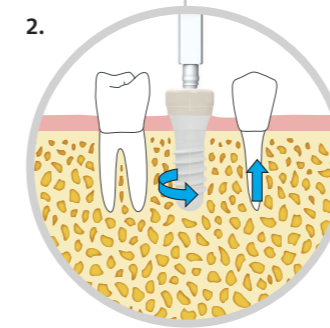

2.

2. To remove the gingiva former, insert the prosthetic wrench and turn counterclockwise.

### Required material:

- Gingiva former (P35503/P35504/P36503/P36504)
- Prosthetic wrench (P38619/P38623)

**DO NOT OVER-TIGHTEN!**  
Force does not need to be applied to insert the gingiva former. Carefully screw in to the full depth.

**IMPORTANT:**  
The transfer sleeves must be snapped into the hex head socket and must mate securely. To check, apply a slight countermovement.

## Closed tray

### In the office:

1. **Positioning:** Place the transfer sleeve on the external hexagon under slight pressure while turning until it **snaps into the hex head socket**, rests securely on the implant shoulder, and can no longer be rotated.

2. **Screwing tight:** Tighten the lukewarm locking pin clockwise, and check the position for a form-fit. In case of doubt, take an X-ray.

3. **Taking an impression:** Prepare the impression with a closed tray and remove. Unscrew the locking pin, remove the transfer from the implant, and give the transfer and impression to the dental technician.

### In the laboratory:

4. **Connecting:** Place the transfer sleeve on the external hexagon under slight pressure while turning until it **snaps into the hex head socket of the implant replica**, rests securely on the shoulder, and can no longer be rotated. Screw the lukewarm locking pin tight clockwise.

5. **Reposition and create a model:** Reposition the transfer in the impression with the screwed-on implant replica and ensure that the seat is secure. Create a master model.

6. **Restoration:** Select a secondary component depending on the prosthetic requirements and the related procedure. Straight and angular screw-retained abutments (more on page 29) and straight and angular cemented abutments and Locator® (more on page 37) are available.

**Required material:**  
• Transfer sleeve SN/RN (P35512/P35513/P36512/P36513)  
• Implant replica SN/RN (P35520/P36520)

## Open tray

### In the office:

1. **Positioning:** Place the transfer sleeve on the external hexagon under slight pressure while turning until it **snaps into the hex head socket**, rests securely on the implant shoulder, and can no longer be rotated.

2. **Screwing tight:** Screw the transfer sleeve hand-tight. Tighten the lukewarm locking pin clockwise, and check the position for a form-fit. In case of doubt, take an X-ray.

3. **Taking an impression:** Create the impression with an open tray. Unscrew and remove the locking pin. Remove the impression, and give it to the dental technician with the locking pin.

### In the laboratory:

4. **Connecting:** Place the implant replica on the external hexagon under slight pressure while turning until it **snaps into the transfer sleeve**, rests securely on the shoulder, and can no longer be rotated. Tighten the locking pin clockwise under lukewarm conditions.

5. **Creating the model:** Reposition the transfer with the screwed-on implant replica, and make sure that the seat is secure. Create a master model. Remove the locking pin before removing the impression.

6. **Restoration:** Select a secondary component depending on the prosthetic needs and the preferred procedure. Straight and angular screw-retained abutments (more on page 29) and straight and angular cemented abutments and Locator® (more on page 37) are available.

**Required material:**  
• Transfer sleeve SN/RN (P35512/P35513/P36512/P36513)  
• Implant replica SN/RN (P35520/P36520)

**IMPORTANT:**  
Secure the parts against being aspirated when they are used in the patient's mouth.

## Prosthetic procedure

### Indications

ZERAMEX®P6 are used for the following indications:

- Individual tooth restoration
- Bridges over several implants
- Bars over several implants
- Bar/hybrid restoration in combination with Locator®

**IMPORTANT:** For restorations worn with Locator®, only cemented Locator® abutments are available.

### 1 Preparation phase

Prosthetic restoration is governed by the overall approach for achieving the best possible results. Integral functionality, aesthetics and patient comfort are the primary considerations. The initial step is a detailed analysis (including X-rays) which includes the patient's medical history. Therapy plan is developed with the primary considerations in mind.

### 2 Gingiva management

A pink appearance reflects healthy gingiva. For this reason, any disorders must be treated before implantation. Soft tissue grows well around zirconium oxide, which is of great relevance, especially in the anterior region. A natural emergence profile is individually created using a gingiva former or a provisional, and the "black triangle" is a thing of the past.

### 3 Abutment/implant connection

- There are two basic options for a metal-free, aesthetic and biologically compatible restoration:
- Screw-retained straight and angular P6 abutments (p.29)
  - Cemented straight and angular ZERALOCK™ abutments and Locator® (p.37)

The range of fully metal-free prosthetics is extensive and satisfies the stringent requirements with regard to aesthetics and functionality. The ZERAMEX® P6 implant with its various abutments is optimum for nearly every situation.

### 4 Workflow

The ZERAMEX® P6 implant system integrates seamlessly with conventional procedure using manual, direct, and indirect impressions and in a digital workflow with intra-oral scanning and direct production of restorations.

SN  
ø 4.0mm

The prosthetic parts marked yellow are for the SN platform (3.3mm-diameter implant).

RN  
ø 4.8mm

The prosthetic parts marked red are for the RN platform (4.1mm-diameter and 4.8mm-diameter implant).

## ZERAMEX®P6 – Tools

Abutment Holder  
Set SN & RN Straight

P6 Abutments



P38644S

ZERALOCK™ Abutments



P38645S

ZERAMEX® P6 Ratchet

Surgical ratchet

P4893S



Ratchet Adapter Unit, Short

P4893Z



ZERAMEX® P6 Alignment  
Tool

T38626



ZERAMEX® P6 Prosthetic  
Wrench

P38623



ZERAMEX® P6 Prosthetics Kit

P48860 Tray

P48865 Fully equipped Tray incl. Ratchet

(Planning set and placeholder not included)

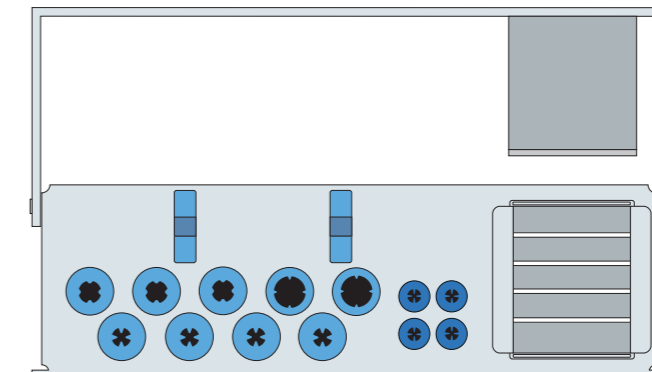

Placeholder

SN 3.0mm

P35453



RN 3.3mm

P36453



ZERAMEX® P6 Abutment  
Planning Kit

P18550



# ZERAMEX® P6

## Screwed connection

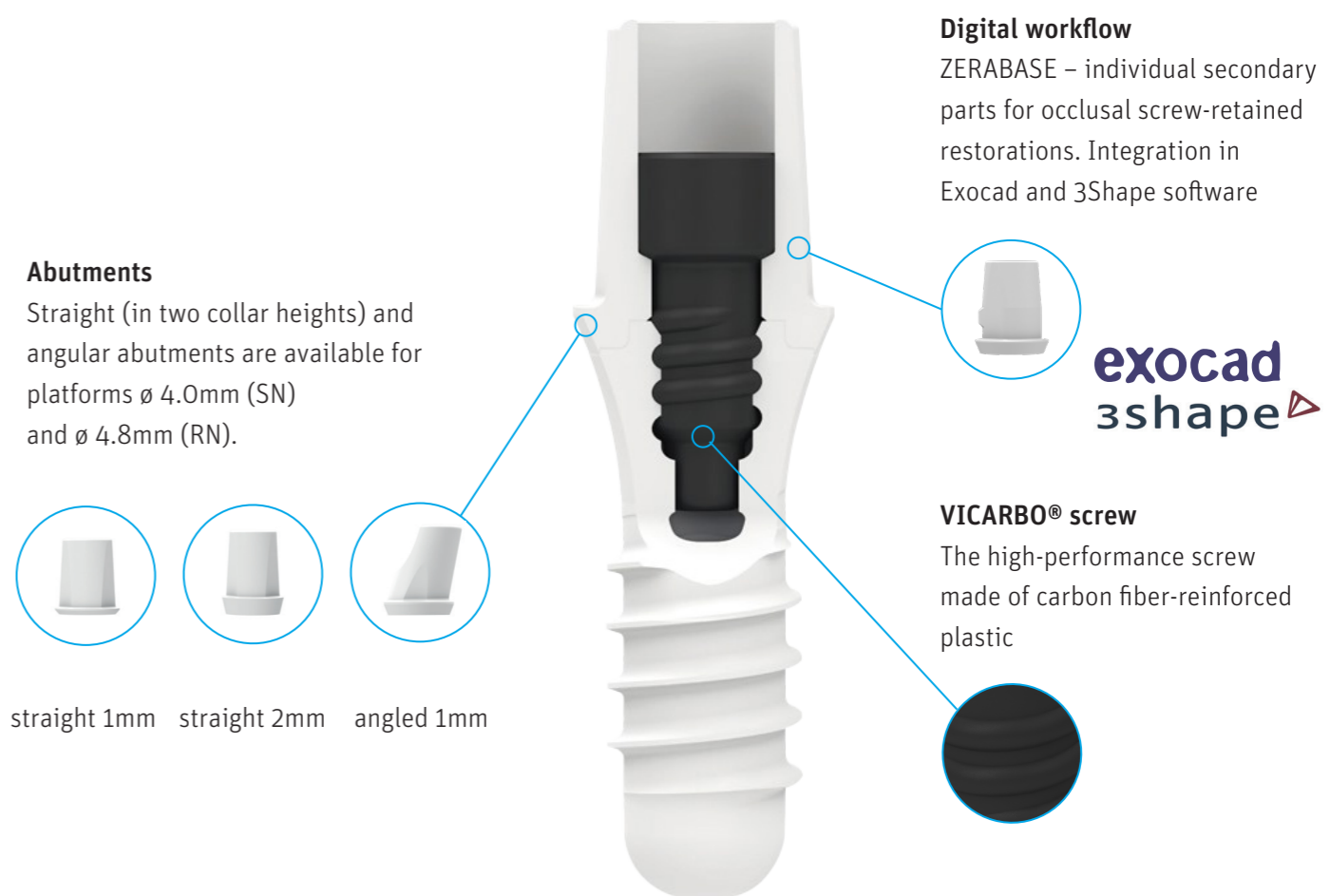

**NOTE:**

All abutments and abutment fixation screws provided non-sterile **MUST** be sterilized prior to use with the sterilization parameters provided in our "Guidelines for sterilization and instrument care" (Art. PP99926).

## Production of the superstructure in the laboratory

The ZERAMEX® P6 system offers reversible screwing into zirconium. The internal thread makes it possible to screw prosthetic parts and zirconium dioxide abutments into implants. The anti-rotation protection on the platform allows secondary parts to be securely and precisely positioned, while the VICARBO® screw ensures that they are firmly seated.

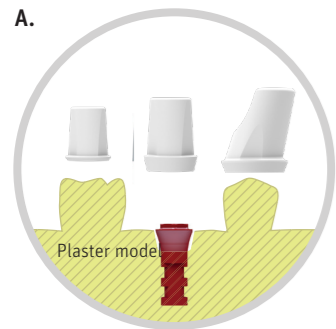

**A:** Select abutment based on planning set.

**Tip:** Use an individual positioning wrench for angled abutments or complex restorations.

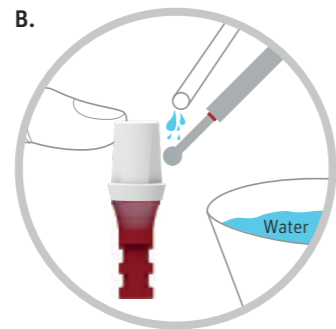

**B:** If necessary, individually machine the abutment. Only process the abutment under sufficient, continuous cooling with slight pressure. Use high speeds (turbines) and fine grain size (red-ring diamond, smaller than 50µm). **Note:** Local overheating causes micro-fissures and destruction of the abutment.

**C.** All P6 abutments are approved for the following methods:

✓ adhesion, ✓ milling, ✓ pressing

You can choose a monolithic crown (**C1.**) or full-ceramic crown on a zirconium dioxide cap (**C2.**)

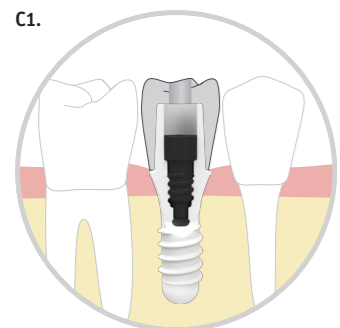

**C1.** Monolithic crowns consisting of a range of optimized synthetics or zirconium dioxide

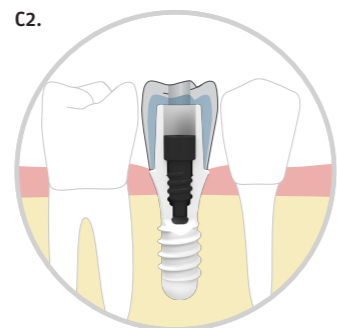

**C2.** Full-ceramic crowns made of layered or pressed ceramic on a zirconium dioxide cap

### Everything you need for the laboratory at a glance:

- Each abutment is supplied with a VICARBO® screw.
- Each VICARBO® screw may only be tightened once to the maximum torque.
- The maximum permissible torque for SN: 25Ncm; for RN: 35Ncm.
- For work in the laboratory, we offer **laboratory screws** that can be tightened using 5Ncm.
- Adapt your approach to the anatomical situation and do not use over-dimensioned crowns or connections to natural teeth (hybrid restoration).
- Do not use floating crown attachments with an abutment.
- When grinding the abutment, an additional replica can be used as a holder. Counterpressure with the fingers reduces vibration.

**IMPORTANT:** It is essential to consider the minimum layer thickness according to the manufacturer's instructions for the specific crown material.

## Occlusal screwed connection in the patient's mouth

The diameter of the screw channel must be determined in advance for occlusal screwing of the finished abutment/crown bond. Here you can work using the placeholders SN (screw channel > 3.0mm) and RN (screw channel > 3.3mm) or reduce the diameter (screw channel > 2.2mm).

### Restoration with placeholders:

When using placeholders, make sure that the screw channel diameter allows the VICARBO® screw to be inserted into and removed from the abutment and crown at any time, even when the crown is already tightly cemented to the abutment.

#### SN platform

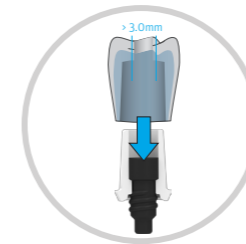

The diameter of the screw channel for the VICARBO® screw must be greater than 3.0mm for the SN platform.

#### RN platform

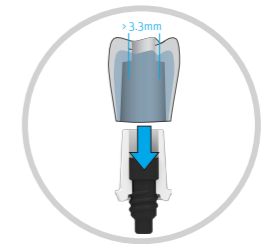

The diameter of the screw channel for the VICARBO® screw must be greater than 3.3mm for the RN platform.

You can make your own positioning aids/placeholders or order them separately:

SN platform: P35453 placeholder SN 3.0mm; RN platform: P36453 placeholder RN 3.3mm

### Screw channel with a reduced diameter

You can also use screw channels with a reduced diameter instead of placeholders. With this, the screw channel diameter can be reduced to less than 2.2mm. The prosthetic wrench (P38623) can be used as a positioning aid/placeholder.

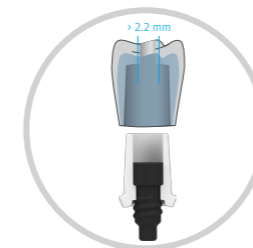

The diameter of the screw channel for the reduced diameter version must be less than 2.2mm.

### IMPORTANT:

- When reduced-diameter screws are used, the VICARBO® screw must be inserted in the abutment in the laboratory before the crown is secured onto the abutment.
- The VICARBO® screw cannot be screwed in or out after the crown has been cemented.
- When cementing the crown, excess cement must not enter the screw channel of an inserted screw (insert cotton wad or a similar placeholder that can be removed from the screw channel).
- If the abutment is shortened, make sure that the VICARBO® screw has sufficient vertical space to be screwed in and out.



**DO NOT OVER-TIGHTEN!**  
 The one-off maximum torque for the VICARBO® screw is:  
 Platform ø 4.0mm **SN: 25Ncm**  
 Platform ø 4.8mm **RN: 35Ncm**

## Occlusal screwed connection in the patient's mouth

- Required material:**
- Abutment incl. VICARBO® screw (P15501/P15502/P15515/P16501/P16502/P16515)
  - Prosthetic Wrench (P38619/P38623)
  - Abutment Holder Set SN & RN Straight (P38644S)
  - Torque Ratchet (P48935) and Adapter (P48932)

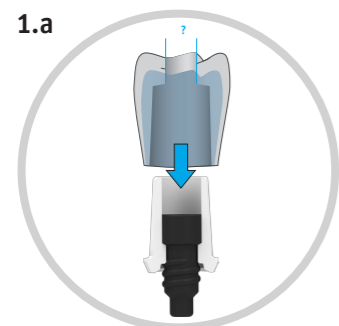

**1.a** The cap can be veneered by pressing or layering. Use the following procedure to select the diameter of the screw channel:

- SN abutments: > 3.0mm
- RN abutments: > 3.3mm
- Reduced diameter: > **2.2mm\***

**\*IMPORTANT:** When using a reduced-diameter screw, place the screw in the abutment before cementing the crown on top. Note the information on page 31.

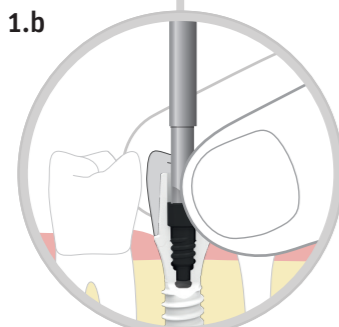

**1.b** Place the abutment with the cemented crown on the implant. Apply slight pressure to fit the abutment/crown until it snaps into place in the correct **position** (hex head socket!). **Hold the abutment/crown** and tighten the screw in the screw channel by applying pressure from the occlusal direction. Use the prosthetic wrench and the torque ratchet (**SN: 25Ncm/RN: 35Ncm**). Use a **probe and/or X-ray** to check if the abutment is correctly seated.

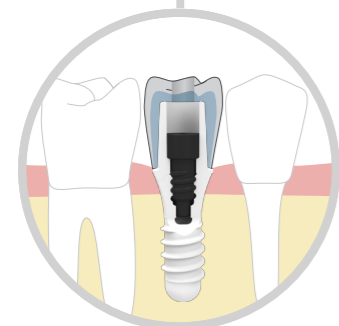

**IMPORTANT:**  
 Prior to final tightening, ensure that the abutment is clean and is resting on the implant shoulder, meaning that it is fully locked into the hex head socket. Never tighten the screw in a tilted position.

## Cementing the crown in the patient's mouth

If a screw channel is not possible or required, the crown can be produced in the laboratory without a screw channel.

- Required material:**
- Abutment incl. VICARBO® screw (P15501/P15502/P15515/P16501/P16502/P16515)
  - Prosthetic Wrench (P38619/P38623)
  - Abutment Holder Set SN & RN Straight (P38644S)
  - Torque Ratchet (P48935) and Adapter (P48932)

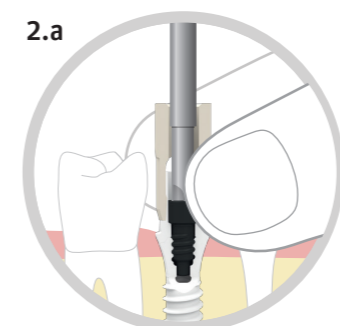

**2.a** Place screw in abutment. Place abutment using the abutment holder (P38644S/P38645S). Apply slight pressure to rotate the abutment until it snaps into place in the correct **position** (hex head socket!). **Hold the abutment holder tight** and tighten the screw using the abutment holder by applying pressure from the occlusal direction. Use the prosthetic wrench and the torque ratchet (**SN: 25Ncm/RN: 35Ncm**). Use a **probe and/or X-ray** to check if the abutment is correctly seated.

**NOTE:** Use of the abutment holder is optional and provides holding assistance for straight abutments, where possible. An individual positioning wrench may need to be made for the restorations.

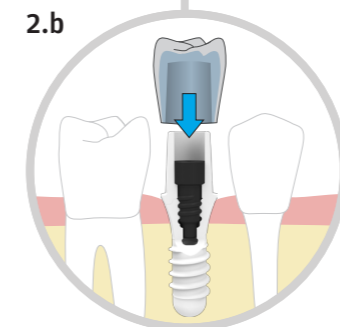

**2.b** The cap can be veneered by pressing or layering. Cement the finished crown onto the tightly screwed abutment.

**NOTE:** There is a specific VICARBO® screw for each abutment. Note the VICARBO® datasheet.

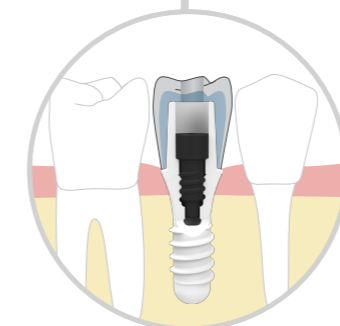

## ZERABASE for individualized abutments

### Screwed, full ceramic restorations

ZERAMEX® allows you to combine 100% metal-free dentures with highly efficient workflows. ZERAMEX® ZERABASE gives you the base for your individually shaped abutment for occlusal screw-retained restorations. Work with your preferred work process and use Exocad or 3Shape software for digital workflows.

### High flexibility

- Design the abutment according to your requirements
- Individual shaping facilitates an optimum aesthetic appearance
- Residual cement can be removed easily and safely since preparation margins can be shaped ideally
- Design the abutment in a way that achieves ideal crown support and stable fit
- Made for screw-retained and cement-retained restorations



### Work processes

The ZERAMEX® ZERABASE Abutment allows you to work with your preferred work process.

### Conventional work process

- Creating wax-up for molded or milled restorations

### Digital work process (digital design using Exocad or 3Shape software)

- Machined abutment → scan without Scanbody and create the design in the software
- Non-machined abutment → scan in Scanbody and create the design in the software

### Production

The cap or crown is milled in your laboratory, in the milling center of your choice, or chair-side.

### Leading software

The ZERAMEX® ZERABASE Abutments are integrated in the market-leading systems: Exocad and 3Shape.

**Exocad:** The library will be updated automatically to include the ZERAMEX® ZERABASE Abutments. 

Exception: Systems from Zirkozahn and Amann Girrbach require that files be imported manually.

**3Shape:** Please download the files from our website and import them into your system. 

You can find all of the files on our website: [www.zeramex.com](http://www.zeramex.com)

### Features & benefits



### The right match for your indication

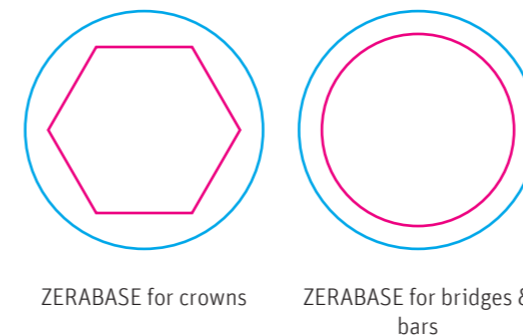

### ZERABASE Abutment

- Precise, stable ZERAMEX® original connection for high stability
- Retentive element and phase for precise placing of cap or crown
- Adherends for optimum retention and adhesion of the restoration

### ZERAMEX® Scanbody

- Ideal geometry for precise digital recording
- Stable plastic for multiple use in the laboratory
- Scanbody tightening torque: max. 15Ncm

### ZERABASE for crowns (engaging):

The hexagonal design ensures protection against rotation on the implant.

### ZERABASE for bridges and bars (non-engaging):

The implant is connected through a circular platform, not hexagonal.

### Processing information and material

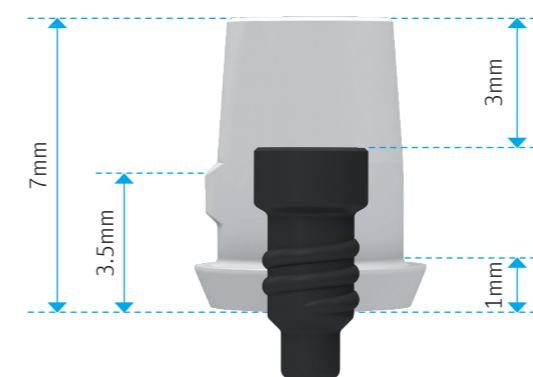

### Processing information

- Conical part can be shortened by 3mm, up to the height of the screw head
- Only machine under good, continuous cooling with slight pressure
- Use high speed (turbines) and fine grain size (red-ring diamond, smaller than 50µm)
- Final tightening torque of abutment (in lab: use lab screws):
  - RN: 35Ncm
  - SN: 25Ncm
- CTE for ZrO<sub>2</sub> ATZ: 9 x 10<sup>-6</sup>/K
- Adhesion with commercially-available adhesives

### Material

- ZERABASE Abutments: zirconium dioxide, ATZ
- ZERAMEX® Scanbody: PEEK
- Screw: VICARBO® (carbon-fiber-reinforced plastic)



# TECHNICAL DATA FOR ZERAMEX® P6 ABUTMENTS

## ZERAMEX® P6

### Bonded connection

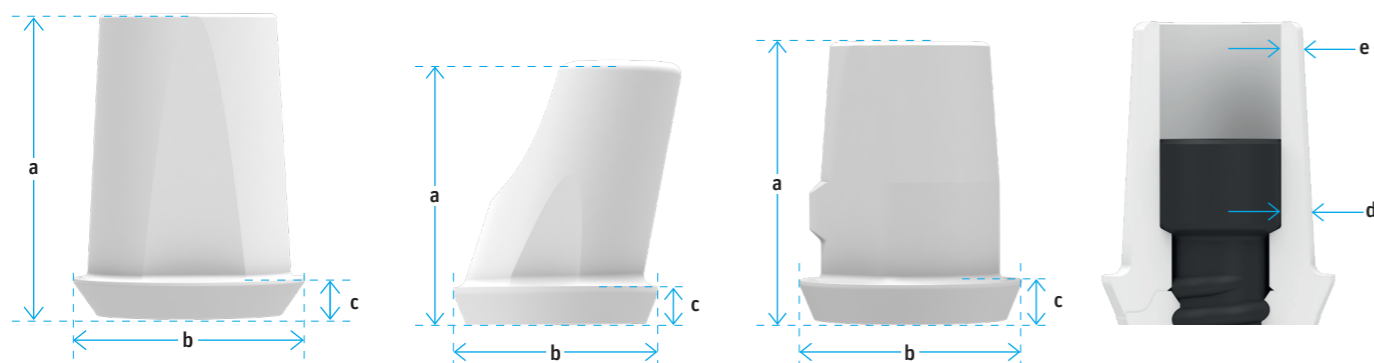

**SN**  
ø 4.0mm

		a	b	c	d	e
P15501	ZERAMEX® P6 Abutment SN Straight, 1mm	6.5	5.0	1.0	0.6	0.5
P15502	ZERAMEX® P6 Abutment SN Straight, 2mm	7.5	5.0	2.0		
P15515	ZERAMEX® P6 Abutment SN Angular 15°, 1mm	5.5	5.0	1.0		
P15530	ZERAMEX® P6 ZERABASE SN, for crown	7.0	5.0	1.0		
P15531	ZERAMEX® P6 ZERABASE SN, for bridge	7.0	5.0	1.0		

All dimensions are in millimeters

**RN**  
ø 4.8mm

		a	b	c	d	e
P16501	ZERAMEX® P6 Abutment RN Straight, 1mm	7.0	5.8	1.0	0.7	0.6
P16502	ZERAMEX® P6 Abutment RN Straight, 2mm	8.0	5.8	2.0		
P16515	ZERAMEX® P6 Abutment RN Angular 15°, 1mm	7.0	5.8	1.0		
P16530	ZERAMEX® P6 ZERABASE RN, for crown	7.0	5.6	1.0		
P16531	ZERAMEX® P6 ZERABASE RN, for bridge	7.0	5.6	1.0		

All dimensions are in millimeters

#### Material

- ZrO<sub>2</sub>-ATZ-HIP
- Zirconium dioxide, ATZ (alumina-toughened zirconia)
- Composition
- ZrO<sub>2</sub>: 76%
- Al<sub>2</sub>O<sub>3</sub>: 20%
- Y<sub>2</sub>O<sub>3</sub>: 4%
- Flexural strength: 2,000 MPa
- CTE for ATZ: 9 x 10<sup>-6</sup>/K

#### Grinding the abutment

- The conical part can be shortened down to the height of the screw head
- Only machine under good, continuous cooling with slight pressure
- Use high speed (turbines) and fine grain size (red-ring diamond, smaller than 50 µm)
- Final tightening torque
  - SN: 25Ncm
  - RN: 35Ncm

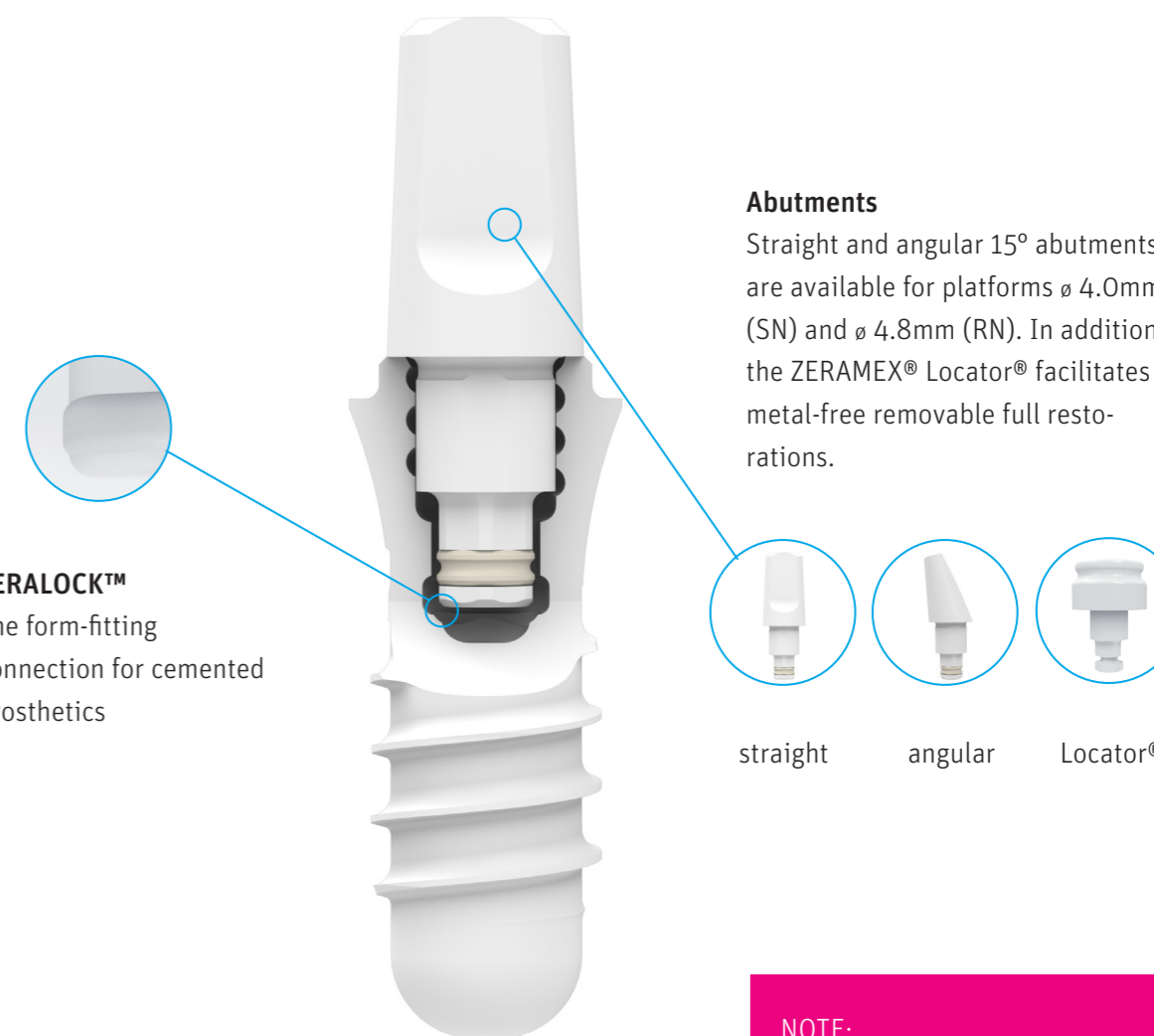

#### Abutments

Straight and angular 15° abutments are available for platforms ø 4.0mm (SN) and ø 4.8mm (RN). In addition the ZERAMEX® Locator® facilitates metal-free removable full restorations.

#### ZERALOCK™

The form-fitting connection for cemented prosthetics

straight      angular      Locator®

**NOTE:**  
All abutments and abutment fixation screws provided non-sterile **MUST** be sterilized prior to use with the sterilization parameters provided in our "Guidelines for sterilization and instrument care" (Art. PP99926).

**NOTE:**  
Do not apply cement directly into the implant!  
Always apply it to the ABUTMENT.

## Production of the superstructure in the laboratory

ZERAMEX® ZERALOCK™ abutments can be connected to the implant using a precise cylinder. The patented ZERALOCK™ connection ensures secure positioning of the abutment. The definitive bonding creates a permanent connection and can help minimize the accumulation of bacteria.

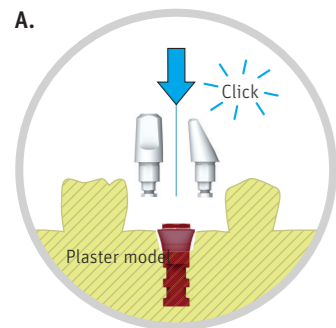

**A.** Select abutment based on planning set. Straight and angular abutment: **click into place.**

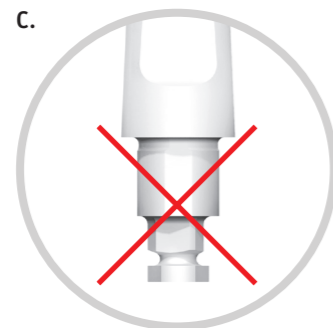

**C. NOTE:** Do not sandblast or machine the abutment hex. Avoid hot spots caused by flames or lasers.

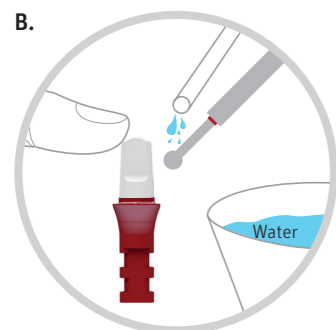

**B.** Machine the abutment individually if necessary. Process the abutment only under sufficient, continuous cooling with slight pressure and using diamond polishers designed for zirconium dioxide. Use high speeds. Note: Local overheating causes micro-fissures and destruction of the abutment.

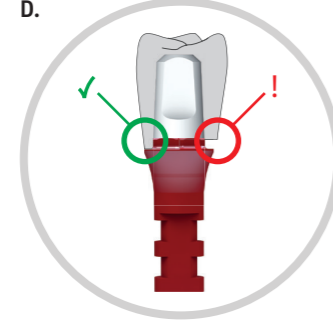

**D.** The superstructure must sit perfectly against the platform. Take into account the cement gap during production.

### Everything you need for the laboratory at a glance:

- Adapt your approach to the anatomical situation and do not use over-dimensioned crowns or connections to natural teeth.
- When machining the abutment, use a replica as a holder and produce counter pressure with your fingers (reduces vibrations).
- Create an individual wrench for angular abutments or complex restorations.
- Do not use “floating crown attachments” with an abutment.
- Use only diamond polishers with fine grain size (smaller than 50µm). Work using high speeds and consistently good water cooling.

## General information on cementing

- Required material:**
- Panavia™ 2.0, Kuraray or
  - RelyX™ Unicem, 3M or
  - Saremco els cem
  - Abutment and abutment holder (optional)

**Note:**  
Aside from cleaning and drying, the inside of the implant and abutment do not need pre-treatment.

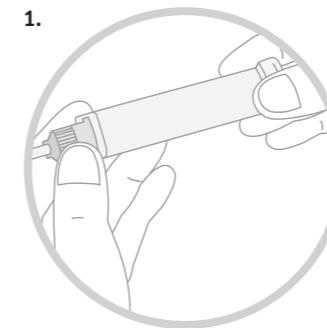

**1.** See the manufacturer's instructions when preparing the adhesive.

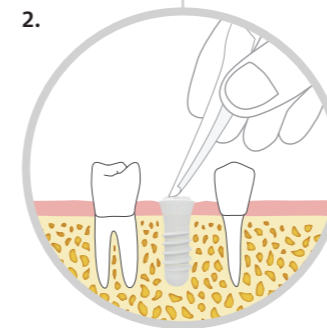

**3.** Use alcohol to clean and degrease the inside of the implant and abutment. Keep the inside of the implant dry. **Optional:** Place sutures around the implant.

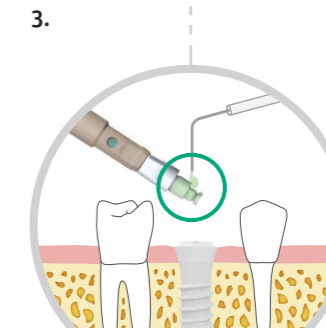

**3.** Apply a small amount of cement to the abutment and distribute using tip of the needle or disposable brush. **Straight and angular abutments:** Insert the abutment until it “clicks” (do not turn). If an individual wrench is used, allow for enough curing time prior to removal. **Locator®:** Insert Locator® in the implant and lock into place in the implant by rotating it 60 degrees.

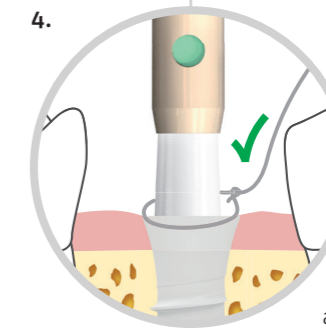

**4. Correct:** The abutment must rest perfectly on the implant shoulder! The cement has to cure fully. Afterwards remove the suture and excess cement.

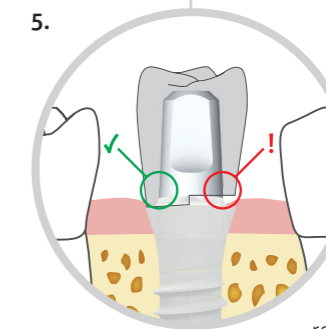

**5. Cement crown:** The crown must rest perfectly on the implant shoulder. Completely remove residual cement.

# CEMENTED RESTORATION

## Direct impressions

As an alternative to indirect impressions, you can take direct impressions.

**Required material:**

- Panavia™ 2.0, Kuraray or
- RelyX™ Unicem, 3M or
- Saremco els cem
- Abutment and abutment holder (optional)

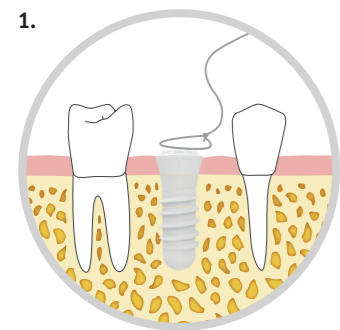

**1.** Expose implant and select the abutment according to the planning set. As an option, place a suture to remove residual cement safely.

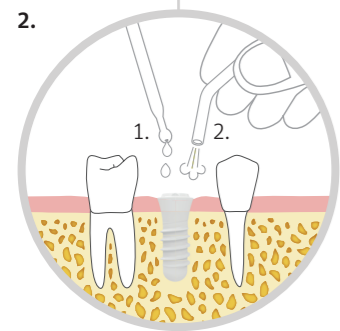

**2.** Clean the inside of the implant using alcohol (1.) and dry for cementing (2.). Keep the inside of the implant dry pointed paper tips.

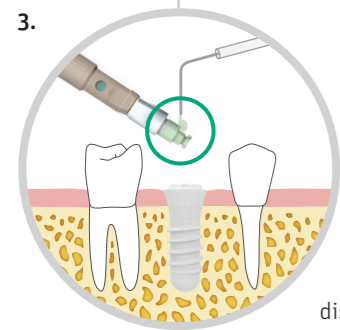

**3.** Apply a small amount of cement to the abutment and distribute using tip of the needle or disposable brush.

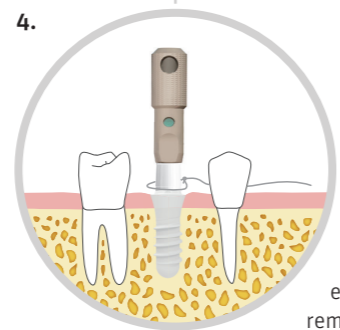

**4. Straight and angular abutments:** Insert the abutment until it “clicks” (do not turn). If an individual wrench is used, allow for enough curing time prior to removal. **Locator®:** Insert Locator® in the implant and lock into place in the implant by rotating it 60 degrees.

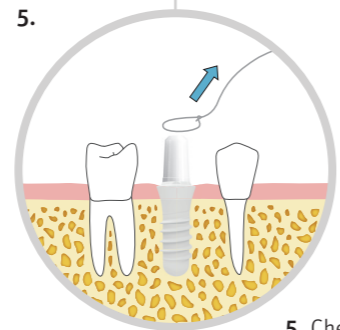

**5.** Check abutments for correct fit and allow to cure for about 10 minutes. Remove the suture and excess cement.

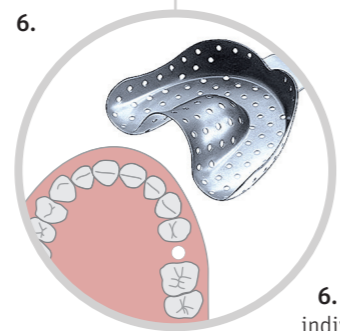

**6.** Abutment can be machined individually if needed.\* When doing so, absolutely ensure good cooling and use proper diamond instruments (fine grain size) and slight pressure.\* Take impressions and proceed as would be done with a natural tooth.

\* Use only special abrasive products for finishing. Zirconium dioxide can become hot in places, reaching 600°C. Avoid this local overheating by using turbines with water cooling and applying slight contact pressure.

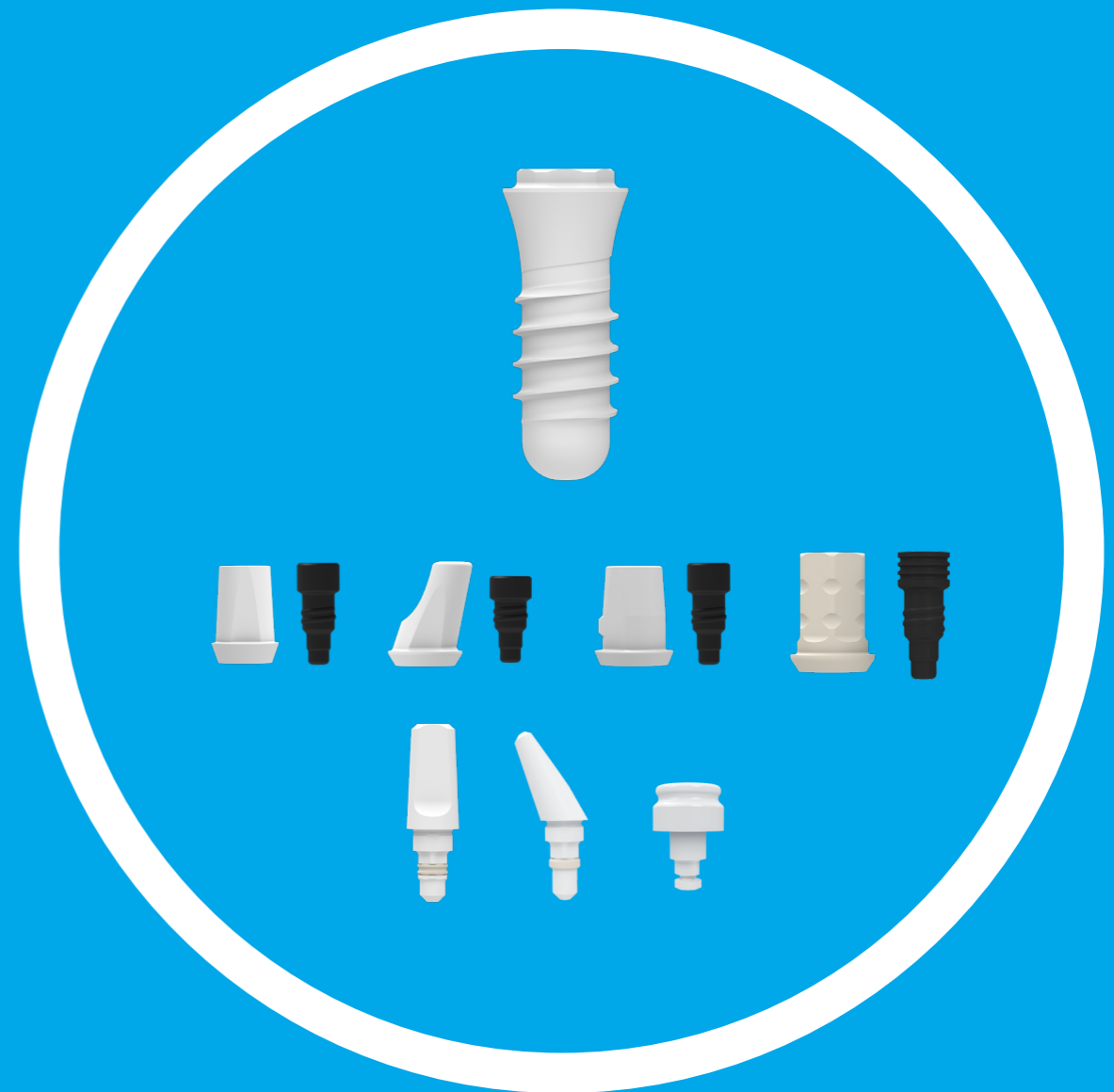



# ZERAMEX® P6

Product range

## ZERAMEX®P6 Implants



Ø 3.3 mm	Art. No.	Name	Dimension	Material
	P15508	ZERAMEX®P6 Implant Ø 3.3 x 8 mm SN (incl. healing cap)	Length: 8mm	ZrO <sub>2</sub> -ATZ-HIP
	P15510	ZERAMEX®P6 Implant Ø 3.3 x 10 mm SN (incl. healing cap)	Length: 10mm	
	P15512	ZERAMEX®P6 Implant Ø 3.3 x 12 mm SN (incl. healing cap)	Length: 12mm	

Ø 4.1 mm	Art. No.	Name	Dimension	Material
	P16508	ZERAMEX®P6 Implant Ø 4.1 x 8 mm RN (incl. healing cap)	Length: 8mm	ZrO <sub>2</sub> -ATZ-HIP
	P16510	ZERAMEX®P6 Implant Ø 4.1 x 10 mm RN (incl. healing cap)	Length: 10mm	
	P16512	ZERAMEX®P6 Implant Ø 4.1 x 12 mm RN (incl. healing cap)	Length: 12mm	

Ø 4.8 mm	Art. No.	Name	Dimension	Material
	P17508	ZERAMEX®P6 Implant Ø 4.8 x 8 mm RN (incl. healing cap)	Length: 8mm	ZrO <sub>2</sub> -ATZ-HIP
	P17510	ZERAMEX®P6 Implant Ø 4.8 x 10 mm RN (incl. healing cap)	Length: 10mm	
	P17512	ZERAMEX®P6 Implant Ø 4.8 x 12 mm RN (incl. healing cap)	Length: 12mm	





## ZERAMEX® P6 Abutments

SN Platform	Art. No.	Name	Dimension	Material
	P15501	ZERAMEX®P6 Abutment SN Straight, 1 mm (incl. screw)	AH: 6.5mm, CH: 1mm	ZrO <sub>2</sub> -ATZ-HIP VICARBO®
	P15502	ZERAMEX®P6 Abutment SN Straight, 2 mm (incl. screw)	AH: 6.5mm, CH: 2mm	
	P15515	ZERAMEX®P6 Abutment SN Angular 15°, 1 mm (incl. screw)	AH: 5.5mm	ZrO <sub>2</sub> -ATZ-HIP VICARBO®

### CAD/CAM

	P15530	ZERAMEX®P6 ZERABASE SN, for crown (incl. screw)	AH: 7mm, CH: 1mm	ZrO <sub>2</sub> -ATZ-HIP VICARBO®
	P15531	ZERAMEX®P6 ZERABASE SN, for bridge (incl. screw)	AH: 7mm, CH: 1mm	

RN Platform	Art. No.	Name	Dimension	Material
	P16501	ZERAMEX®P6 Abutment RN Straight, 1 mm (incl. screw)	AH: 7mm, CH: 1mm	ZrO <sub>2</sub> -ATZ-HIP VICARBO®
	P16502	ZERAMEX®P6 Abutment RN Straight, 2 mm (incl. screw)	AH: 8mm, CH: 2mm	
	P16515	ZERAMEX®P6 Abutment RN Angular 15°, 1 mm (incl. screw)	AH: 7mm, CH: 1mm	ZrO <sub>2</sub> -ATZ-HIP VICARBO®

### CAD/CAM

	P16530	ZERAMEX®P6 ZERABASE RN, for crown (incl. screw)	AH: 7mm, CH: 1mm	ZrO <sub>2</sub> -ATZ-HIP VICARBO®
	P16531	ZERAMEX®P6 ZERABASE RN, for bridge (incl. screw)	AH: 7mm, CH: 1mm	

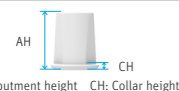



The ZERABASE Abutments are integrated in the 3Shape and Exocad systems.

VICARBO® screws	Art. No.	Name	Dimension	Material
	P15450	ZERAMEX®P6 VICARBO SN Straight	Length: 7.3mm	VICARBO®
	P15451	ZERAMEX®P6 VICARBO SN Angular	Length: 6.25mm	
	P16450	ZERAMEX®P6 VICARBO RN Straight	Length: 7.5mm	
	P16451	ZERAMEX®P6 VICARBO RN Angular	Length: 6.7mm	

## ZERAMEX® ZERALOCK™ Abutments



### Straight & angular abutments

SN Platform	Art. No.	Name	Dimension	Material
	P15305	ZERAMEX® ZERALOCK™ Abutment SN straight	AH: 6mm	ZrO <sub>2</sub> -ATZ-HIP
	T15315	ZERAMEX® ZERALOCK™ Abutment SN angular 15°	AH: 5.4mm	

RN Platform	Art. No.	Name	Dimension	Material
	P16305	ZERAMEX® ZERALOCK™ Abutment RN straight	AH: 6mm	ZrO <sub>2</sub> -ATZ-HIP
	T16315	ZERAMEX® ZERALOCK™ Abutment RN angular 15°	AH: 5.5mm	





### LOCATOR®

SN Platform	Art. No.	Name	Dimension	Material
	P15202	ZERAMEX® ZERALOCK™ Locator® 2 mm SN	Height: 2mm	ZrO <sub>2</sub> -ATZ-HIP
	P15203	ZERAMEX® ZERALOCK™ Locator® 3 mm SN	Height: 3mm	
	P15205	ZERAMEX® ZERALOCK™ Locator® 5 mm SN	Height: 5mm	
RN Platform	Art. No.	Name	Dimension	Material
	P16202	ZERAMEX® ZERALOCK™ Locator® 2 mm RN	Height: 2mm	ZrO <sub>2</sub> -ATZ-HIP
	P16203	ZERAMEX® ZERALOCK™ Locator® 3 mm RN	Height: 3mm	
	P16205	ZERAMEX® ZERALOCK™ Locator® 5 mm RN	Height: 5mm	





## ZERAMEX® Prosthetics - SN Platform

Soft Tissue Management	Art. No.	Name	Dimension	Material
	P35500	ZERAMEX®P6 Healing Cap SN	Height: 0.5mm	PEEK
	P35503	ZERAMEX®P6 Gingiva Former SN, 3 mm	Height: 3mm	
	P35504	ZERAMEX®P6 Gingiva Former SN, 4 mm	Height: 4mm	
	P35530	ZERAMEX®P6 Provisional SN (incl. screw)	AH: 7mm CH: 1mm	PEEK, PEEK-CW30

Impression Taking	Art. No.	Name	Dimension	Material
	P35510	ZERAMEX®P6 Transfer Open Tray SN	Sleeve height: 10mm Height incl. screw: 19mm	PEEK-CW30, Aluminum
	P35512	ZERAMEX®P6 Transfer Closed Tray SN	Sleeve height: 7mm Height incl. screw: 14mm	
	P35513	ZERAMEX®P6 Transfer Closed Tray, long SN	Sleeve height: 11mm Height incl. screw: 19mm	PEEK-CW30, Aluminum
	P35514	ZERAMEX®P6 Scanbody SN	Height: 10mm	



# PRODUCT RANGE





## ZERAMEX® Prosthetics - SN Platform

Auxiliaries	Art. No.	Name	Dimension	Material
	P35520	ZERAMEX®P6 Implant Replica SN	Height: 10mm	Aluminum
	P35550	ZERAMEX®P6 Provisional Screw SN	Length: 7.3mm	PEEK-CW30
	P35553	ZERAMEX®P6 Lab Screw SN	Length: 6.2mm	PEEK









## ZERAMEX® Prosthetics - RN Platform

Soft Tissue Management	Art. No.	Name	Dimension	Material
	P36500	ZERAMEX®P6 Healing Cap RN	Height: 0.6mm	PEEK
	P36502	ZERAMEX®P6 Closure Screw RN	Height: 0.5mm	
	P36503	ZERAMEX®P6 Gingiva Former RN, 3 mm	Height: 3mm	
	P36504	ZERAMEX®P6 Gingiva Former RN, 4 mm	Height: 4mm	
	P36530	ZERAMEX®P6 Provisional RN (incl. screw)	AH: 7mm CH: 1mm	PEEK, PEEK-CW30

Impression Taking	Art. No.	Name	Dimension	Material
	P36510	ZERAMEX®P6 Transfer Open Tray RN	Sleeve height: 11mm Height incl. screw: 20mm	PEEK-CW30, Aluminum
	P36512	ZERAMEX®P6 Transfer Closed Tray RN	Sleeve height: 7mm Height incl. screw: 14mm	PEEK-CW30, Aluminum
	P36513	ZERAMEX®P6 Transfer Closed Tray, long RN	Sleeve height: 11mm Height incl. screw: 18mm	PEEK-CW30, Aluminum
	P36514	ZERAMEX®P6 Scanbody RN	Height: 10mm	PEEK, PEEK-CW30

Auxiliaries	Art. No.	Name	Dimension	Material
	P36520	ZERAMEX®P6 Implant Replica RN	Height: 10mm	Aluminum
	P36550	ZERAMEX®P6 Provisional Screw RN	Length: 6.1mm	PEEK-CW30
	P36553	ZERAMEX®P6 Lab Screw RN	Length: 5.2mm	PEEK
	P18550	ZERAMEX®P6 Abutment Planning Kit		PEEK

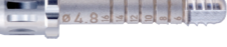





## ZERAMEX® Tools

	Art. No.	Name	Material
	P35601	ZERAMEX®P Rose Drill ø 2.2 mm	Stainless steel
	P35602	ZERAMEX®P Pilot Drill ø 2.2 mm	
	P35633	ZERAMEX®P Drill ø 2.8 mm	
	P36633	ZERAMEX®P Drill ø 3.5 mm	
	P37633	ZERAMEX®P Drill ø 4.2 mm	
	P35622	ZERAMEX®P Profile Drill SN ø 2.8 mm	
	P36622	ZERAMEX®P Profile Drill ø 3.5 mm	
	P35650	ZERAMEX®P Depth Gauge ø 2.0 mm	
	P36650	ZERAMEX®P Depth Gauge ø 3.0 mm	
	P35620	ZERAMEX®P Screw Tap ø 3.3 mm	
	P36620	ZERAMEX®P Screw Tap ø 4.1 mm	
	P37620	ZERAMEX®P Screw Tap ø 4.8 mm	
	P38619	ZERAMEX® Prosthetic Wrench, 19 mm	
	P38623	ZERAMEX® Prosthetic Wrench, 23 mm	
	T38620	ZERAMEX® Pickup 20 mm	
	T38622	ZERAMEX® Rescue Pickup	
	T38625	ZERAMEX® Pickup 25 mm	
	T38626	ZERAMEX® Alignment Tool	
	C7650	Drill extension	







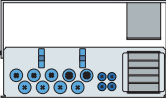



























# PRODUCT RANGE

## ZERAMEX® Tools

	Art. No.	Name	Material
	P35453	ZERAFIX™ Placeholder SN 3.0mm	PEEK
	P36453	ZERAFIX™ Placeholder RN 3.3mm	
	P38645S	ZERALOCK™ Abutment Holder Set SN & RN	PEEK
	P38644S	ZERAFIX™ Abutment Holder Set SN & RN	
	P48850	ZERAMEX®P Surgery Tray	Stainless steel
	P48854	ZERAMEX®P Surgery Tray, fully equipped with ratchet	
	P48870	ZERAMEX®P Surgery Tray "mini"	
	P48932	ZERAMEX®P Ratchet Adapter Unit Short	
	P48935	ZERAMEX®P Surgical Ratchet	
	P48860	ZERAMEX®P Prosthetics Tray	
	P48865	ZERAMEX®P Prosthetics Kit, incl. ratchet	

## ZERAMEX® Locator® Accessories

	Art.No.	Name	Material
	T38219	LOCATOR® Processing Denture Cap (up to 10° divergence per implant, clear, pink, blue), 2pcs.	Ti/Nylon/LDPE
	T38220	LOCATOR® Processing Denture Cap (up to 20° divergence per implant, green, orange, red), 2pcs.	Ti/Nylon/LDPE
	T38222	LOCATOR® Blockout Spacer, 20pcs.	Silicone rubber
	T38224	LOCATOR® Impression Coping, 4pcs.	Al housing with LDPE lining
	T38226	LOCATOR® Replica Ø4mm, 4pcs.	Aluminum
	T38227	LOCATOR® Replica Ø5mm, 4pcs.	Aluminum
	T38228	LOCATOR® Core Tool	Stainless steel
	T38230	LOCATOR® Replacement clear, 4pcs. Retention force: 2.27kg	Nylon
	T38231	LOCATOR® Replacement pink, 4pcs. Retention force: 1.36kg	
	T38232	LOCATOR® Replacement blue, 4pcs. Retention force: 0.68kg	
	T38233	LOCATOR® Replacement green, 4pcs. Retention force: 1.81kg	
	T38234	LOCATOR® Replacement orange, 4pcs. Retention force: 0.91kg	
	T38235	LOCATOR® Replacement red, 4pcs. Retention force: 0.45kg	

	0050	 Note (observe accompanying documents)
	Order number	 Expiry date:
	Batch ID	 Follow the instructions for use
	Do not reuse	 Manufacturing date:
	Steam sterilized	 Manufacturer
	Unsterile	 Do not use if packaging is damaged
	Keep away from sunlight	 The products of the portfolio are FDA approved
	Keep dry	 Prescription use only
	Implant small ø3,3mm SN (Platform ø4,0mm)	 Implant small ø4,1mm RN (Platform ø4,8mm)
	Implant small ø4,8mm RN (Platform ø4,8mm)	





# General information

## Warranty

Dentalpoint AG offers a lifelong warranty for implants, and a 10-year warranty for P6 abutments and VICARBO® screws.

Details of the warranty terms and conditions can be found in the document “ZERAMEX® Warranty”.

## Delivery and packaging

Deliveries are in accordance with the general terms and conditions of Dentalpoint AG. Intact double-sterile packaging protects the implant from external influences and ensures sterile storage up to the printed expiration date. ZERAMEX®P6 implants and components must be stored dry in their original packaging at room temperature and protected from sunlight.

Only open the packaging shortly before surgery. We recommend comprehensive clinical, radiological and statistical documentation.

The inside labels (patient label) allow traceability of the implants.

## Exclusion of liability

ZERAMEX®P6 implants are part of an overall system and may be used only with the components designed for this system. Dentalpoint AG will not be held liable for any damage arising from improper use, or from using non-original components. The general terms and conditions of Dentalpoint AG also apply.

## Training

For information on courses and further education for ZERAMEX®P6, please contact us at [www.zeramex.com](http://www.zeramex.com).

## Training

For information on courses and further education for ZERAMEX®P6, please contact us at [www.zeramex.com](http://www.zeramex.com).

## Material properties

All implants and abutments are made from hot-densified zirconium oxide ATZ-HIP® (HIP = Hot Isostatic Postcompaction). For reasons of quality and strength, the implants and abutments are strictly machined into their final shape from solid, hard blanks using diamond-coated tools. In this process, the workpiece cannot become deformed, as would happen in processing prior to sintering. This allows for highly precise and reproducible production of implants and abutments with the necessary precise fit.

## ZERAFIL™ implant surface

- Microstructured
- Blasted and thermally etched
- Hydrophilic

## ZrO2-ATZ-HIP

Zirconium dioxide, ATZ (alumina-toughened zirconia), radiopaque.

### Composition:

ZrO<sub>2</sub> 76%, Al<sub>2</sub>O<sub>3</sub> 20%, Y<sub>2</sub>O<sub>3</sub> 4%  
Flexural strength: 2,000 MPa

## PEEK Classix

Polyetheretherketone USP Class VI (not radio-opaque)

## Aluminum

Aluminum AW70-75 (not radio-opaque)

## PEEK Classix CW30 LSG

Short carbon fibers (CF) in a PEEK Classix LSG matrix. (Not radio-opaque)

### Composition:

CF 30%, PEEK Classix LSG 70%.  
Flexural strength: >130 MPa

## VICARBO® (PEEK Optima™ Ultra Reinforced) unidirectional carbon fiber (CF)

in PEEK-OPTIMA™ matrix. (not radio-opaque)

### Composition:

CF 60%, PEEK-OPTIMA™ 40%.  
Flexural strength: >1,100 MPa

### **Order hotline AUS**

T +64 9 414 4238

[order@zeramexaustralasia.com](mailto:order@zeramexaustralasia.com)

### **Manufacturer**

Dentalpoint AG

Bodenäckerstrasse 5

8957 Spreitenbach/Switzerland

T 0041 44 388 36 36

F 0041 44 388 36 39

### **Australian Sponsor**

Emergo Australia

Level 20, Tower II, Darling Park

201 Sussex Street, Sydney, NSW 2000

Australia

[info@zeramexaustralasia.com](mailto:info@zeramexaustralasia.com)

[www.zeramexaustralasia.com](http://www.zeramexaustralasia.com)